

Robot Vacuum & Mop Combo



COPYRIGHT © Hangzhou EZVIZ Software Co., Ltd. ALL RIGHTS RESERVED.

Any and all information, including, among others, wordings, pictures, graphs are the properties of Hangzhou EZVIZ Software Co., Ltd. (hereinafter referred to as “EZVIZ”). This user manual (hereinafter referred to as “the Manual”) cannot be reproduced, changed, translated, or distributed, partially or wholly, by any means, without the prior written permission of EZVIZ. Unless otherwise stipulated, EZVIZ does not make any warranties, guarantees or representations, express or implied, regarding to the Manual.

About this Manual

The Manual includes instructions for using and managing the product. Pictures, charts, images and all other information hereinafter are for description and explanation only. The information contained in the Manual is subject to change, without notice, due to firmware updates or other reasons. Please find the latest version in the EZVIZ™ website (<http://www.ezviz.com>).

Revision Record

New release – January 2024

Trademarks Acknowledgement

EZVIZ™, ™, and other EZVIZ’s trademarks and logos are the properties of EZVIZ in various jurisdictions. Other trademarks and logos mentioned below are the properties of their respective owners.

Legal Disclaimer

TO THE MAXIMUM EXTENT PERMITTED BY APPLICABLE LAW, THE PRODUCT DESCRIBED, WITH ITS HARDWARE, SOFTWARE AND FIRMWARE, IS PROVIDED “AS IS”, WITH ALL FAULTS AND ERRORS, AND EZVIZ MAKES NO WARRANTIES, EXPRESS OR IMPLIED, INCLUDING WITHOUT LIMITATION, MERCHANTABILITY, SATISFACTORY QUALITY, FITNESS FOR A PARTICULAR PURPOSE, AND NON-INFRINGEMENT OF THIRD PARTY. IN NO EVENT WILL EZVIZ, ITS DIRECTORS, OFFICERS, EMPLOYEES, OR AGENTS BE LIABLE TO YOU FOR ANY SPECIAL, CONSEQUENTIAL, INCIDENTAL, OR INDIRECT DAMAGES, INCLUDING, AMONG OTHERS, DAMAGES FOR LOSS OF BUSINESS PROFITS, BUSINESS INTERRUPTION, OR LOSS OF DATA OR DOCUMENTATION, IN CONNECTION WITH THE USE OF THIS PRODUCT, EVEN IF EZVIZ HAS BEEN ADVISED OF THE POSSIBILITY OF SUCH DAMAGES.

TO THE MAXIMUM EXTENT PERMITTED BY LICABLE LAW, IN NO EVENT SHALL EZVIZ’S TOTAL LIABILITY FOR ALL DAMAGES EXCEED THE ORIGINAL PURCHASE PRICE OF THE PRODUCT.

EZVIZ DOES NOT UNDERTAKE ANY LIABILITY FOR PERSONAL INJURY OR PROPERTY DAMAGE AS THE RESULT OF PRODUCT INTERRUPTION OR SERVICE TERMINATION CAUSED BY: A) IMPROPER INSTALLATION OR USAGE OTHER THAN AS REQUESTED; B) THE PROTECTION OF NATIONAL OR PUBLIC INTERESTS; C) FORCE MAJEURE; D) YOURSELF OR THE THIRD PARTY, INCLUDING WITHOUT LIMITATION, USING ANY THIRD PARTY’S PRODUCTS, SOFTWARE, APPLICATIONS, AND AMONG OTHERS.

REGARDING TO THE PRODUCT WITH INTERNET ACCESS, THE USE OF PRODUCT SHALL BE WHOLLY AT YOUR OWN RISKS. EZVIZ SHALL NOT TAKE ANY RESPONSIBILITES FOR ABNORMAL OPERATION, PRIVACY LEAKAGE OR OTHER DAMAGES RESULTING FROM CYBER ATTACK, HACKER ATTACK, VIRUS INSPECTION, OR OTHER INTERNET SECURITY RISKS; HOWEVER, EZVIZ WILL PROVIDE TIMELY TECHNICAL SUPPORT IF REQUIRED. SURVEILLANCE LAWS AND DATA PROTECTION LAWS VARY BY JURISDICTION. PLEASE CHECK ALL RELEVANT LAWS IN YOUR JURISDICTION BEFORE USING THIS PRODUCT IN ORDER TO ENSURE THAT YOUR USE CONFORMS TO THE APPLICABLE LAW. EZVIZ SHALL NOT BE LIABLE IN THE EVENT THAT THIS PRODUCT IS USED WITH ILLEGITIMATE PURPOSES.

IN THE EVENT OF ANY CONFLICTS BETWEEN THE ABOVE AND THE APPLICABLE LAW, THE LATTER PREVAILS.

Table of Contents

Overview	1
Package Contents	1
Basis	2
Quick Start Guide	6
Preparation	6
Connect the Power Supply to the Base Station	6
Add Clean Water	7
Install Cleaning Solution	7
Remove Shields	9
Install Side Brushes and Mop Assemblies	10
Get the EZVIZ App	10
Place the Robot	11
First Cleaning	12
Use the Camera Sticker(optional)	13
Operations on the EZVIZ App	13
Routine Maintenance	14
Replace Mop Cloth	15
Empty the Dust Box	16
Clean/Replace Filter	17
Clean the Main Brush	18
Clean Wheels	18
Clean Important Parts	19
Clean Water Tank	20
Replace Cleaning Solution	20
Replace Dust Bag	21
Replace the Side Brushes	21
Clean the Base Station	22
Clean Inlet Air Filter	22
Clean Dust Collection Duct	23
EZVIZ Connect	24
FAQ	25
Appendix	27
Environmental Precautions	27
Rechargeable Lithium ion Battery	28
INFORMATION FOR PRIVATE HOUSEHOLDS	28

Overview

Package Contents



Robot Vacuum & Mop Cleaner *1
(hereinafter referred as to "Robot")



Base Station *1

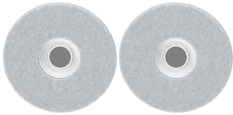

Mop Assembly*2 (Mop cloth included)



Power Cord *1



Side Brush *2



Camera Sticker x1



Cleaning Solution *1



Cleaning Tool *1

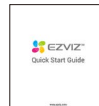

Quick Start Guide *2





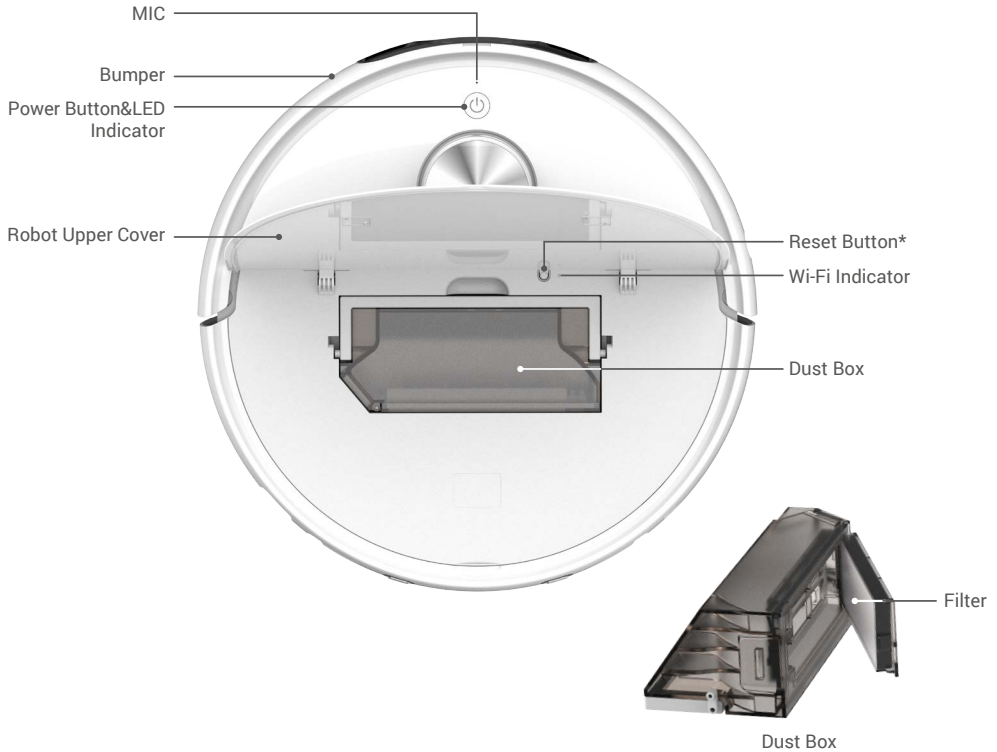

Regulatory Information *1

i The device's appearance is subject to the actual one you have bought.

Basis Robot



Power Button	
Press and hold for 4s	Turn on/off the Robot
Press once	Start/pause the task
Press twice	End the task and return to the Base Station
Press three times	Enable/disable child lock (please enable child lock feature on EZVIZ App in advance)

LED Indicator		
	Orange	In standby mode due to low battery/ task paused
	Red	Fault or exceptions, please check the notification on EZVIZ App
	Blue	In patrol inspection/ remote video
	White	Working properly

Reset Button	
Press and hold for 4s	Robot ready for network configuration
Press and hold for 10s	Restore to factory settings and restart the Robot

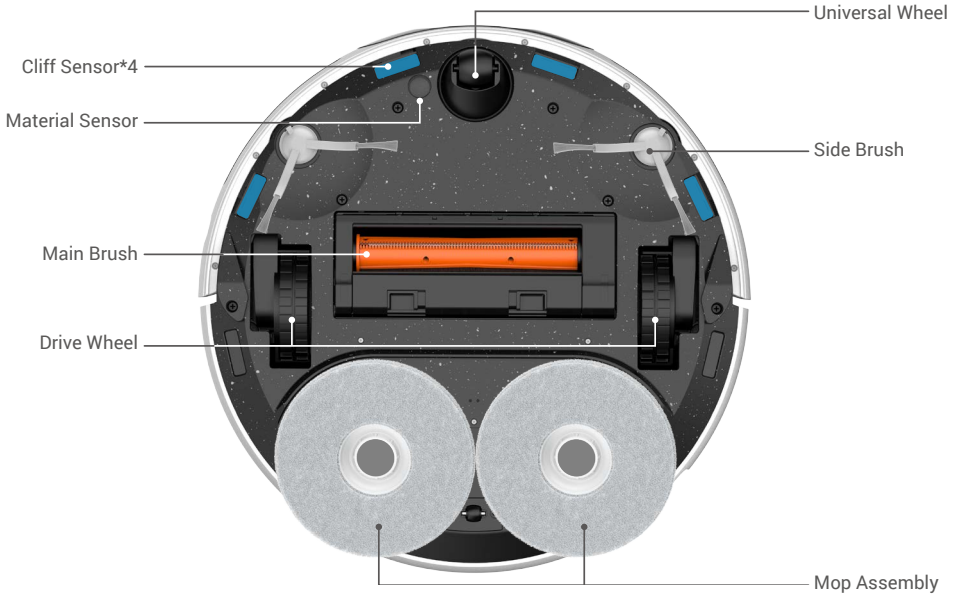
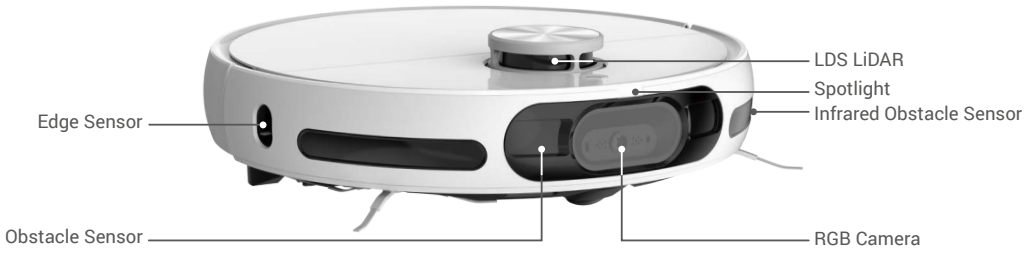

Base Station

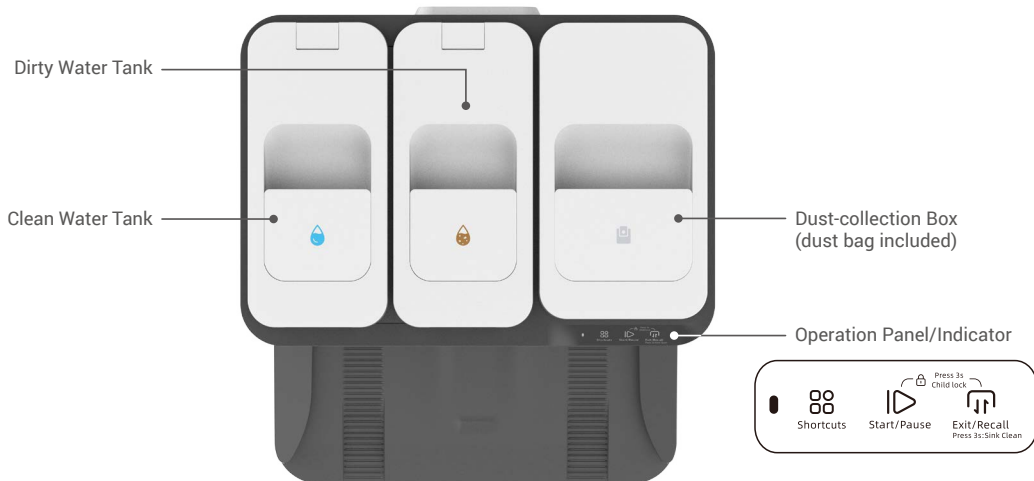

Operation Panel

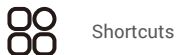

Shortcuts

The corresponding shortcut instructions can be executed through 3 operations (press once, press twice, press and hold for 3s). (Please set shortcut instructions on EZVIZ App in advance)



Start/Pause

Press once: Start/pause task
Press and hold for 3s: End the task



Exit/Recall

Press once: Robot exit/return Base Station
Press and hold for 3s: Start cleaning the cleaning sink of the Base Station, the water sprayed after the Robot exits the Base Station.
Press and hold for 3s again: The Base Station extract dirty water.



Child Lock

Press and hold for 3s: enable/disable child lock
(Please enable the child lock feature on the EZVIZ App in advance)

Indicator on Base Station

	Orange	Slight exceptions
	Red	Exceptions, please check the notification on EZVIZ App
	White	Working properly

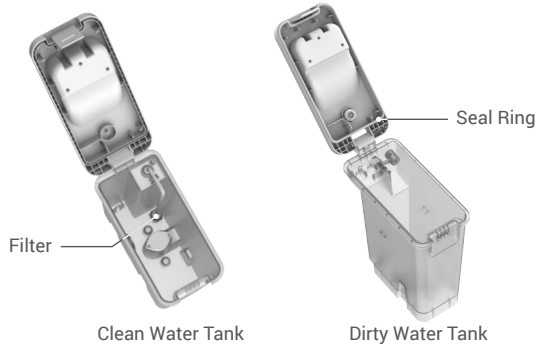
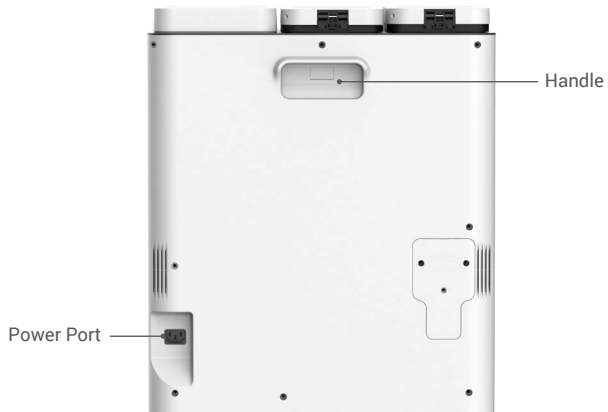

Quick Start Guide

Preparation

Do not use the robot in an environment with stairs (if unavoidable, use a guardrail). Remove any obstacles on the floor before use.

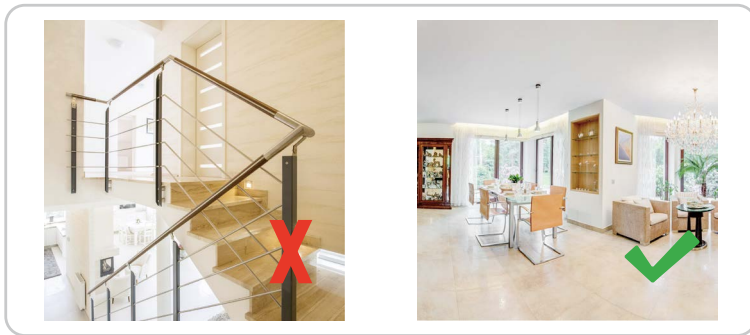

Connect the Power Supply to the Base Station

Select a proper location, place the Base Station on a horizontal floor against the wall, connect the Base Station and the power socket with the power cord, and the Base Station will start automatically (it is recommended to place the Base Station on a flat, light colored tile floor instead of a carpet or wooden floor to avoid wetting them).



- i** In order to avoid external heat damage to the Base Station, please do not place it next to radiators, heaters, fireplaces, etc.
- Do not place the Base Station in damp, rainy, or direct sunlight areas as it may cause damage to the Robot or the Robot can not return to the Base Station.
- The power outlet shall be installed near the power adapter and shall be easily accessible.

Add Clean Water

Remove the protective bags of the clean water tank and the dirty water tank, fill the clean water tank with clean water, and then install them back.

- Do not add hot water, otherwise the device may be damaged.
- Do not add the water filtered by water purifier. It is recommended to add tap water.
- The water can not exceed the max water level line.



Install Cleaning Solution

1. Remove the protective film and the seal on top of the cleaning solution bottle.



2. Take out the dirty water tank.



3. Place the cleaning solution bottle and push it inward, then put back the dirty water tank.

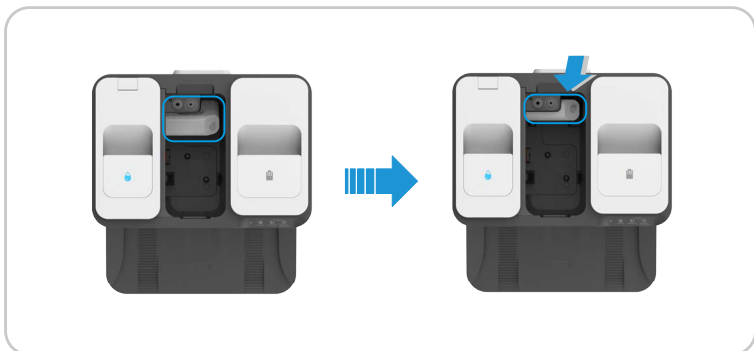

- Please press the cleaning solution bottle into the place during installation.
- Do not use other sterilization solution or cleaning solution not produced by EZVIZ, otherwise the device may be damaged.

Remove Shields

Before use, remove the shields on both sides of the Front Bumper and all protective films on both of the Robot and the Base Station.



Install Side Brushes and Mop Assemblies

1. Align the side brushes with the point as shown in the figure and press them down. Hearing a “click” indicates that they are installed in place.
2. Align the mop assemblies with the magnetic point.

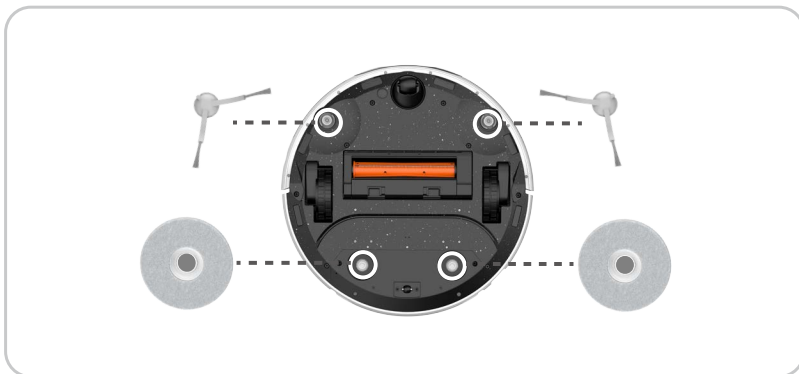

Get the EZVIZ App

1. Connect your mobile phone to Wi-Fi (only 2.4 GHz WiFi is supported).
2. Download and install the EZVIZ App by searching for “EZVIZ” in the App Store or Google Play™.
3. Launch the App and register an EZVIZ user account.

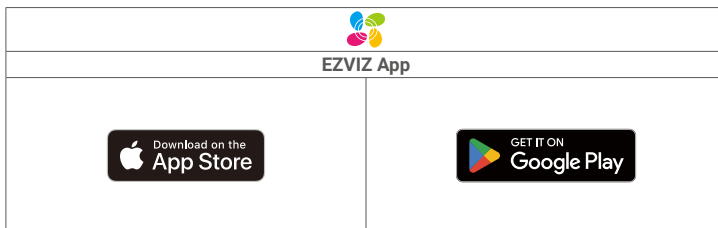

1. If you have already used the App, please make sure that it is the latest version. To find out if an update is available, go to the App store or Google Play™ and search for “EZVIZ”.
- The actual process may vary due to ongoing App updates. Follow the instructions provided in the App.

Add the Robot to EZVIZ App

1. Log in to your account through EZVIZ App, tap the device adding icon and then the QR code scanning interface will be displayed.
2. Press and hold the power button of the robot for 4 seconds until it starts.
3. Open the upper cover of the robot, scan the QR code on the robot body, and complete the network configuration and addition of the robot according to the interface prompts.

i If Wi-Fi connection failed, or you want to connect the robot to another Wi-Fi, press and hold the reset button for 4 seconds, and then the robot will be restarted and you can add the robot to EZVIZ App again.

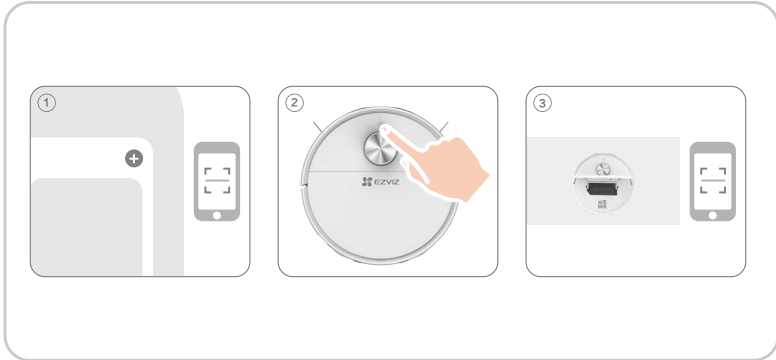

Place the Robot

Place the Robot in front of the Base Station, and then press  on the operation panel. The Robot will enter the Base Station and start charging.

i It is recommended to place the Robot within 50 cm in front of the Base Station to avoid recharging failure.



First Cleaning

Start the cleaning in one of the following three ways.

- Press  button on the Base Station.

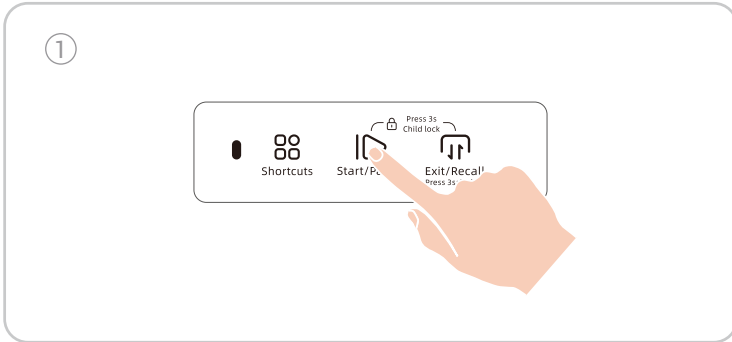

- Log in to your account through EZVIZ App, add device and select the cleaning mode on the home page of the device on the App, and click .

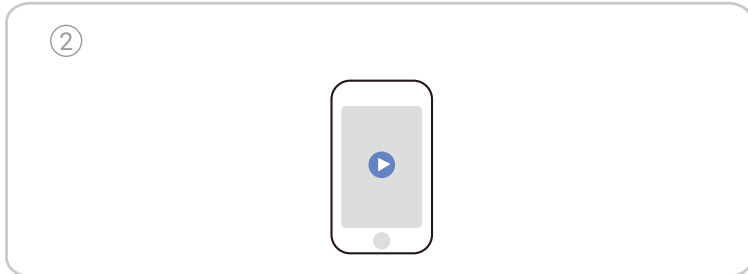

- Press the power button on the Robot.

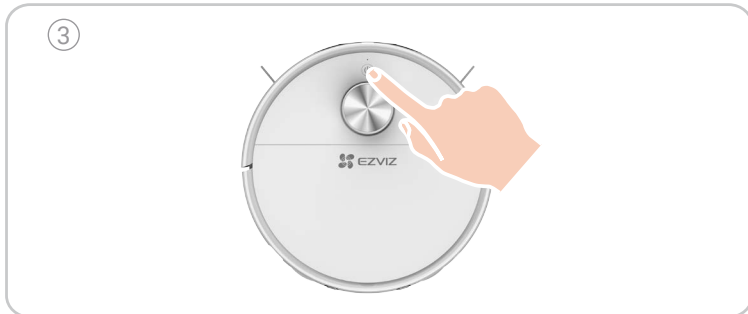

Use the Camera Sticker(optional)

An electrostatic camera sticker is provided if you need to cover the camera.

1. Remove the protective film.
2. Clean and wipe up the the camera with wet tissue. Stick the camera sticker to the camera and press to make it stick firmly.
3. The sticker can be washed and reused.



- ❶ The visual obstacle avoidance is realized through the RGB camera. Covering the lens will affect some of the obstacle avoidance effect. The image processing is done locally and will not be uploaded to EZVIZ Cloud Platform.

Operations on the EZVIZ App

- ❶ The App interface may be different due to version update, and the interface of the App you installed on your phone shall prevail.

Map for Cleaning

Map editing (area dividing, area merging, area building, room naming, no-go zone, invisible wall, rotate, threshold), map zoning, carpet display, real-time cleaning route display and multi-map saving.

Cleaning Method

General cleaning, personalized cleaning, designated room cleaning and area cleaning.

Cleaning Settings

Suction setting, water volume setting, cleaning sequence setting, carpet boost, supplementary sweeping for carpet and self-cleaning for main brush.

Surveillance Feature

Scheduled patrol inspection, fixed-point movement, snapshot/record in patrol inspection, voice intercom.

Information Display

Cleaning history, patrol inspection history, Robot power, consumables and maintenance.

More Features

Firmware upgrade, volume adjustment, scheduled cleaning, Do Not Disturb mode, night vision light compensation and etc.

Routine Maintenance

Please maintain the device and replace parts with following frequencies to keep a best performance.

Robot Part	Maintenance Frequency	Replacement Frequency
Mop Cloth	/	Every 2-3 months
Side Brush	Once every 2 weeks	Every 3-6 months
Main Brush	Once per week	Every 6-12 months
Dust Bag	/	Every 3-4 months
High Efficiency Filter	Once per week	Every 3-6 months
LDS LiDAR RGB Camera Edge Sensor Obstacle Sensor Cliff Sensor Infrared Receiving Terminal Bumper Charging Contact Universal Wheel/Drive Wheel	Once per week	/
Cleaning Sink	Once every 2 weeks	/
Clean Water Tank	Once every 3 months	/
Dirty Water Tank	After each mopping	/
Base Station	Once every 2 weeks	/

- 1 • Before maintenance, turn the Robot OFF and unplug the Base Station.
- A multi-function Cleaning Tool is provided for easy maintenance. Note that the Cleaning Tool has sharp edges.
- EZVIZ manufactures various replacement parts and fittings. Please visit www.ezviz.com for more information on replacement parts.
- Accessories are considered consumables and regular maintenance and replacement are recommended. Due to their wear characteristics, they are not subject to the standard product warranty period.

Replace Mop Cloth

1. Press  button on operation panel of the Base Station, the Robot exits the Base Station.

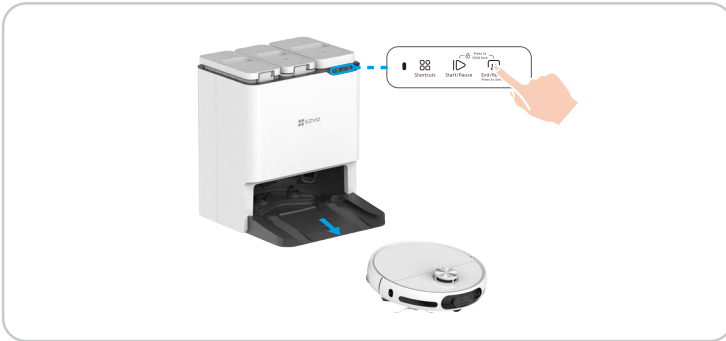

2. Turn the Robot over, take off the mop assemblies.

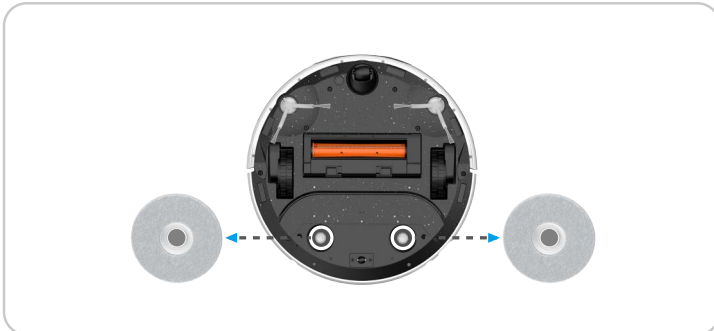

3. Remove the old mop clothes from the mop assemblies and replace a new one, then put the mop assemblies back to the Robot.

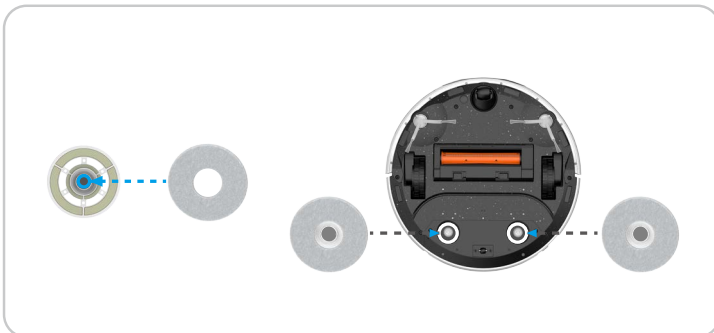

Empty the Dust Box

1. Open the upper cover of the Robot, take out the dust box.



2. Unfasten the buckle on the side of the dust box, open the dust box cover and pour out the garbage inside of it.

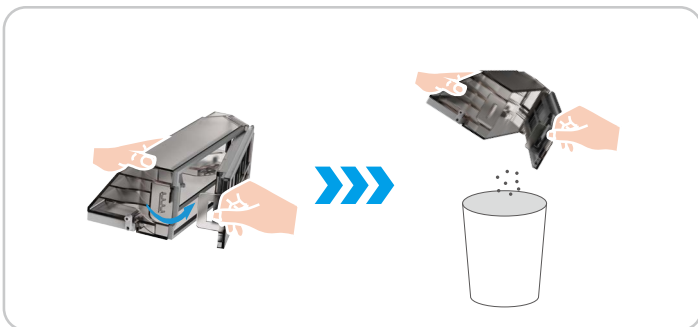

3. Put back the dust box and close the upper cover.



- 1 • Please make sure that the Dust Box and Filter are properly installed onto the Robot before cleaning.
- Do not schedule the cleaning mission if the dust box or filter is not properly installed.

Clean/Replace Filter

1. Open the upper cover of the Robot, take the dust box out and take off the filter assembly.



2. Slightly pat the filter assembly or clean the filter with the cleaning tool. Rinse the filter with water and thoroughly dry it.

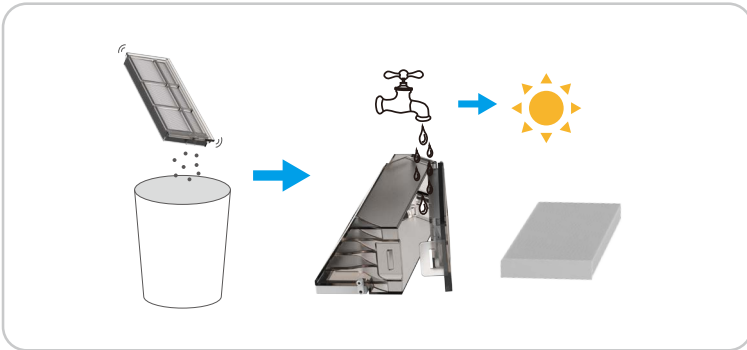

- 1 If the filter is required to be replaced, please take it out from the dust box and replace a new one into it.

Clean the Main Brush

1. Press the buckles to take out the Main Brush cover and the Main Brush.

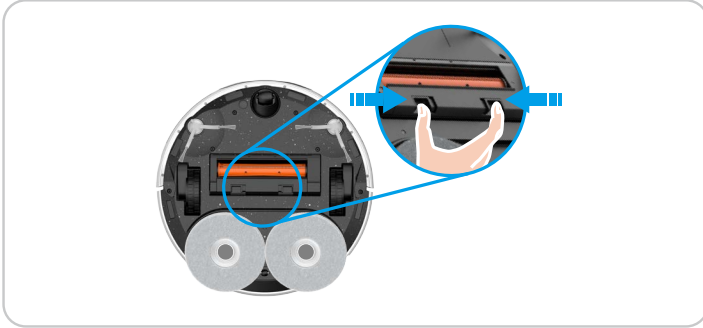

2. Press the button on the end of the cleaning tool and rotate it to take the blade inside of it. Cut off the hair entangled on the Main Brush with blade and remove the roller at one end of the Main Brush to clean it. After cleaning, re-install the Main Brush into place.

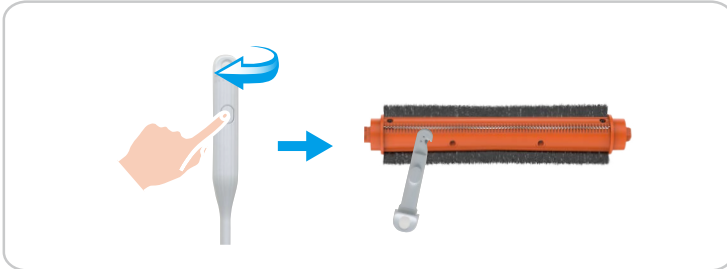

Clean Wheels

1. Pull up the Universal Wheel directly, clean it with the Cleaning Tool and then re-install it into place.
 - i** If there is abnormal sound after a long time using, please remove the universal wheel and add lubricant into the metal shaft.

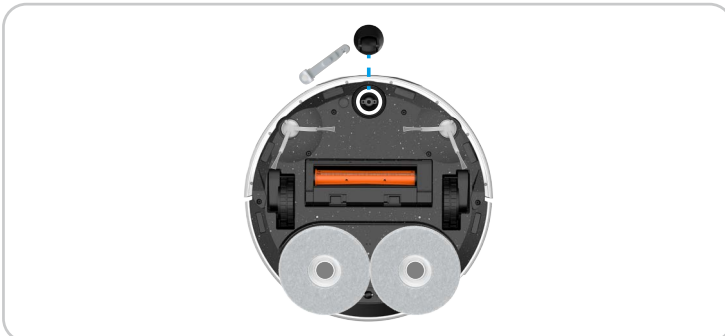

2. Clean the Driven Wheels with the Cleaning Tool.

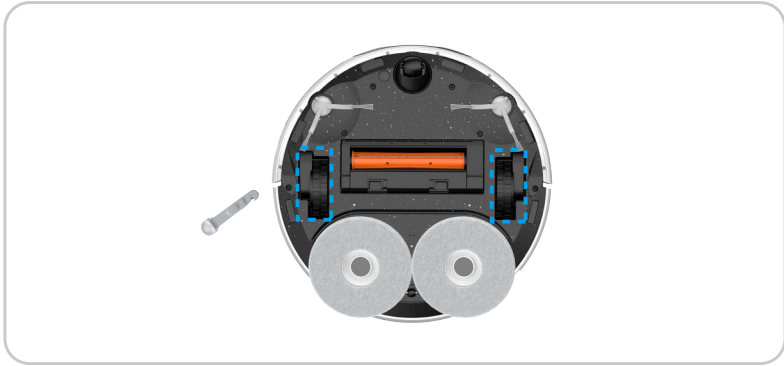

Clean Important Parts

1. Wipe and clean the cliff sensors, material sensor, charging contacts, RGB camera, obstacle sensors, edge sensor and infrared receiving terminal with soft dry cloth.

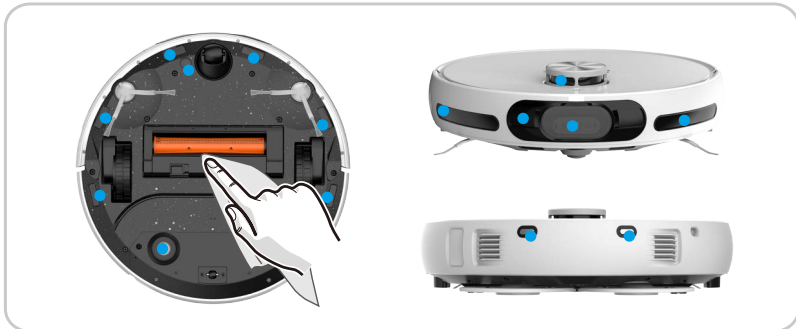

Clean Water Tank

1. Open the cover of the clean water tank, unfasten the buckle and take out the filter upwards to clean it.



2. Pour out the sewage, and use cleaning tool to remove the dirt in the dirty water tank.



Replace Cleaning Solution

1. Remove the protective film and the seal on top of the cleaning solution bottle.
2. Take out the dirty water tank and the empty cleaning solution bottle, install the new cleaning solution bottle. After that, put back the dirty water tank.

Replace Dust Bag

1. Open the upper cover of the dust collection box, lift the handle of the dust bag to take out and discard it.

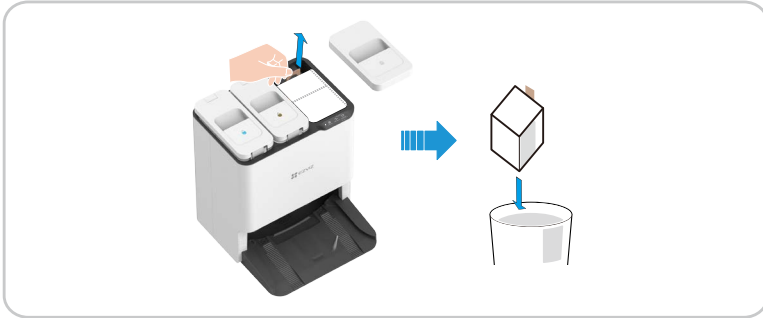

2. Install a new dust bag into place, and then close the upper cover.



Replace the Side Brushes

Pull out the old side brush and then press the new one into the position.

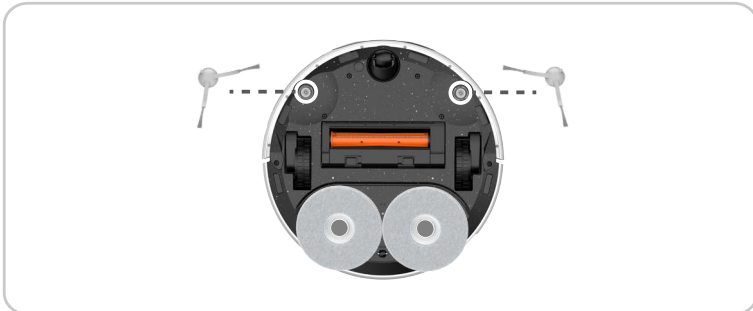

Clean the Base Station

1. Press and hold  button for 3s, the Robot exits the Base Station and the Base Station will spray water.



2. Clean the interior of the Base Station and the cleaning sink with cleaning tool or rags.

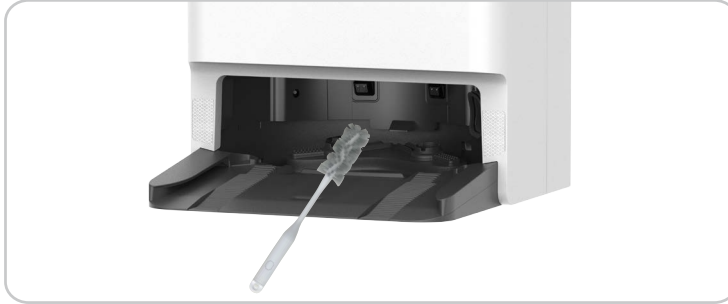

Clean Inlet Air Filter

1. Open upper cover of the dust collection box and then lift the handle of the dust bag. Rotate and take out of the inlet air filter on the bottom of the dust collection box.
2. Rinse with clean water and dry it, and then install back to the dust collection box.



Clean Dust Collection Duct

For Robot: Take out the dust box, clean the dust collection duct with a soft brush.



For Base Station: Take out the dust bag, clean the dust suction port and dust collection duct with a soft brush.



EZVIZ Connect

1. Use Amazon Alexa

These instructions will enable you to control your EZVIZ devices with Amazon Alexa. If you run into any difficulties during the process, please refer to **Troubleshooting**.

Before you start, make sure that:

1. EZVIZ devices are connected to the EZVIZ App.
2. You have an Alexa-enabled device (i.e Echo Spot, Echo-Show, All-new Echo-Show, Fire TV (all generations), Fire TV stick (second generation only), or Fire TV Edition smart TVs).
3. The Amazon Alexa app is already installed on your smart device, and you have created an account.

To Control EZVIZ devices with Amazon Alexa:

1. Open the Alexa app and select "Skills and Games" from the menu.
2. On the Skills and Games screen, search for "EZVIZ", and you will find "EZVIZ" skills.
3. Select your EZVIZ device's skill, then tap ENABLE TO USE.
4. Enter your EZVIZ username and password, and tap Sign in.
5. Tap the Authorize button to authorize Alexa to access your EZVIZ account, so that Alexa can control your EZVIZ devices.
6. You will see "EZVIZ has been successfully linked", then tap DISCOVER DEVICES to allow Alexa to discover all your EZVIZ devices.
7. Go back to Alexa app menu and select "Devices", and you will see all your EZVIZ devices.

Voice Command

-  To use this function, please modify your robot's name(for example: "RS20 Pro") in the EZVIZ App. Every time you change the name of the robot, you will need to discover the device again to update the name.

Discover a new smart device via the "Smart Home" menu in the Alexa app or the Alexa Voice Control function.

Once the device is found, you can control it with your voice. Speak simple commands to Alexa, such as "turn on/turn off + name". For example, speak "turn on RS20 Pro", the robot will start cleaning.

Troubleshooting

What do I do if Alexa fails to discover my device?

Check if there are any Internet connecting problems.

Try to reboot the smart device and re-discover the device on Alexa.

Why does the device's status show "Offline" on Alexa?

Your wireless connection might have been disconnected. Reboot the smart device and re-discover on Alexa.

Internet access on your router could be unavailable. Check if your router is connected to the Internet and try again.

-  For details about countries that support the using of Amazon Alexa, see its official website.

2. Use Google Assistant

With the Google Assistant, you can activate your EZVIZ device by speaking Google Assistant voice commands.

The following devices and apps are required:

1. A functional EZVIZ App.
2. A TV with functional Chromecast connecting to it.
3. The Google Assistant app on your phone.

To get started, follow the steps below:

1. Set up the EZVIZ device and make sure it works properly on the app.
2. Download the Google Home app from the App Store or Google Play Store™ and log into your Google account.
3. On the My home screen, tap "+" on the upper-left corner, and select "Set up device" from the menu list to go to the Set up interface.

4. Tap **Works with Google**, and search for "EZVIZ", where you will find "EZVIZ" skills.
5. Enter your EZVIZ username and password, and tap **Sign in**.
6. Tap the **Authorize** button to authorize Google to access your EZVIZ account, so that Google can control your EZVIZ devices.
7. Tap **Return to app**.
8. Follow the above steps to complete the authorization. When synchronization is completed, EZVIZ service will be listed under your list of services. To see a list of compatible devices under your EZVIZ account, tap on the EZVIZ service icon.
9. Now try some commands with the name of the robot that you created when you set up the system, such as "start/stop/dock/pause/unpause + name". For example, speak "start RS20 Pro", the robot will start cleaning.

Users can manage devices as a single entity or in a group. Adding devices to a room allows users to control a group of devices at the same time using one command.

See the link for more information:

<https://support.google.com/googlehome/answer/7029485?co=GENIE.Platform%3DAndroid&hl=en>

FAQ

Problem	Solution
Charging failure	The Base Station does not connect to the power supply. Please confirm whether the power cord of the Base Station is connected well.
Recharge failure	There are lots of obstacles near the Base Station. Please clean the obstacles in front of the Base Station.
	Recommended place the Robot back to the Base Station before each cleaning task and ensure the Robot starts working from the Base Station.
	High ground resistance. It is suggested to move the Base Station to a flat and light-colored tile floor.
	The floor is slippery. Recommended swipe the floor in front of the Base Station.
	Incorrect Base Station location. Please check whether the location of the Base Station on the map is correct.
	Please do not place the Base Station in direct sunlight.
When in recharge, Operation exception nearby the Base Station	There are obstacles within 80cm in front of the Base Station and within 5cm on the side. Please clear the obstacles directly in front of the Base Station.
	Please use soft material (tissue or soft dry cloth) to swipe the charging contact on the tail of the Robot.
	Please Swipe the driven wheels of the Robot and recharge tracks on the bottom of the Base Station.
	Please confirm whether the Base Station installation location is directly exposed to sunlight.
Abnormal noise/shake during cleaning	Foreign objects entangled to the wheels, side brushes or main brush, please start the Robot after shutting down and clean it.
	The rubber strip on dust collection port is scripping the floor, which is a normal phenomenon.
	If the mop cloth is rolled up, remove the mop assemblies and re-install the mop cloth.
Dirty water tank keeps pumping water	Clean the Base Station. For more information, please refer to "Clean the Base Station".

Cannot connect to Wi-Fi	Poor Wi-Fi signal, please ensure the Robot is in a area with a good Wi-Fi signal.
	Wi-Fi connection exception. Please reset the Wi-Fi and download the latest EZVIZ App, and try to scan the QR code on the Robot to reconnect it.
Cannot avoid obstacles	Use air blowing tool to clean the glass on the lens, or you can use soft tissues or dry cloth to swipe the glass on the lens.
	The obstacle avoidance performance of the Robot will decline when encountering objects with high transmittance (such as glass), high reflectance (such as polished metal), or low reflectance (such as black objects) due to environmental influences.
Abnormal obstacle avoidance	Use air blowing tool to clean the glass on the lens, or you can use soft tissues or dry cloth to swipe the glass on the lens.
Side brush fell off during cleaning	Turn the Robot over and install the side brush again, make sure install it completely until hearing a “clip” sound.
Anti-dropping detection has failed, the Robot can't avoid stairs or high places.	Use soft tissues or dry cloth to swipe the cliff sensors.
Cannot collect dust, poor dust collection effect or abnormal sound in collecting dust	Please check whether the dust collection duct of the Robot and the Base Station is stucked, if so, please refer to the cleaning method of the dust collection duct in this user manual.
	Full dust bag. If so, please replace a new disposable dust bag.
	The air outlet of the Robot's dust box is stucked, please clean it and take the foreign matters out.
Cannot dry automatically	Auto dry feature is off on APP, please check the settings on APP.
	During drying, press the button on the Robot or the Robot exits the Base Station, the drying task ended in advance.
Abnormal operation	If the problem persists after the above possible causes have been considered, the components may be abnormal. Please contact the customer service department.

 For additional information about the Robot, please refer to www.ezviz.com/eu.

Appendix

Environmental Precautions

The chemical substances contained in the built-in lithium-ion battery of this product may cause environmental pollution. Please remove it before scrapping and send it to a professional battery recycling station for centralized disposal.

Steps for removing the battery (the following information is only applicable when discarding the device, not the daily operation instructions):

1. Run the Robot to a low battery status and unable to work, and during this period, do not allow it to return to the base station.
2. Turn off the Robot and remove the side brushes and dust box.
3. Turn the Robot over and remove the screws at the bottom.
4. Remove the battery cover.
5. Take out the battery.

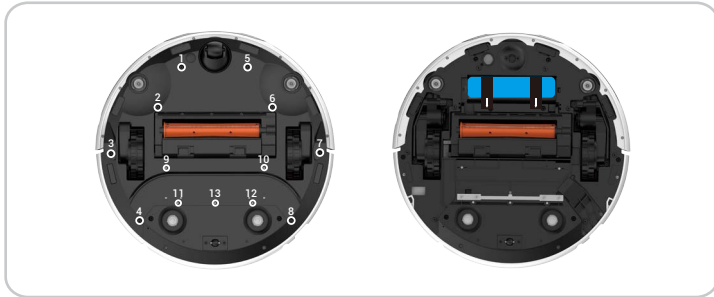

- When disassembling the battery, please ensure that the power is exhausted and operate with the Base Station disconnected.
- Please disassemble the whole battery pack together and do not damage the battery pack casing to avoid short circuit or leakage of hazardous substances.
- If the battery has exudate and accidentally touches it, please flush it with plenty of water and seek medical attention promptly.
- This product should not be discarded after the expiration date or after the repair cannot work normally, please hand it over to an enterprise qualified to dispose of WEEE, please refer to the national or local regulations on the disposal of WEEE for the correct method.
- Standby mode: The Base Station will enter standby mode after the Robot is turned off for 10 minutes: 0.5W.

Rechargeable Lithium ion Battery

1. The battery type of the device: Portable battery.
2. The battery of this device is non-removable, which is risky to remove.

Chemical Composition	Chemical Formula	CAS No.	Weight (%)
Cobalt lithium manganese nickel oxide	Ni, Co, Mn	346417-97-8	36.80%
Graphite	C	7782-42-5	20.20%
Copper foil	Cu	7440-50-8	7.10%
Aluminium	Al	7429-90-5	3.30%
Electrolyte	LiFP ₆	21324-40-3	11.70%
Steel shell	Fe	12597-68-1	14.40%
Steel pouring	Fe	12597-68-1	3.10%
Lead	Pb	7439-92-1	Not Detected
Cadmium	Cd	7440-43-9	Not Detected
Mercury	Hg	7439-97-36	Not Detected

INFORMATION FOR PRIVATE HOUSEHOLDS

1. Separate collection of waste equipment: Electrical and electronic equipment that has become waste is referred to as waste equipment. Owners of waste equipment must dispose of it separately from unsorted municipal waste. In particular, waste equipment does not belong in household waste, but in special collection and return systems.
2. Batteries and rechargeable batteries as well as lamps: Owners of waste equipment shall, as a rule, separate waste batteries and rechargeable batteries that are not enclosed in the waste equipment, which can be removed from the waste equipment without being destroyed, from the waste equipment before handing them in at a collection point. This does not apply if waste equipment is prepared for reuse with the participation of a public waste management authority.
3. Options for returning waste equipment: Owners of waste equipment from private households can return it free of charge to the collection points of the public waste management authorities or to the take-back points set up by manufacturers or distributors within the meaning of the Electrical and Electronics Equipment Law. Stores with a sales area of at least 400 m² for electrical and electronic equipment and those grocery stores with a total sales area of at least 800 m² that offer electrical and electronic equipment several times a year or on a permanent basis and make it available in the market are required to take it back. This also applies in the case of distribution using means of distance communication, if the storage and shipping areas for electrical and electronic equipment are at least 400 m² or the total storage and shipping areas are at least 800 m². Distributors shall, in principle, ensure take-back by providing suitable return facilities at a reasonable distance from the respective end user. The possibility of returning waste equipment free of charge exists for distributors who are obliged to take it back, among other things, if a new similar device that essentially fulfills the same functions is delivered to an end user.
4. Privacy Notice: Waste equipment often contains sensitive personal data. This applies in particular to devices of information and telecommunications technology such as computers and smartphones. In your own interest, please note that each end user is responsible for deleting the data on the waste equipment to be disposed of.
5. Meaning of the symbol "crossed-out wheellie bin": The symbol of a crossed-out wheellie bin regularly depicted on electrical and electronic equipment indicates that the respective device is to be collected separately from unsorted municipal waste at the end of its service life.

Initiatives on the Use of Video Products

Dear Valued EZVIZ Users,

Technology affects every aspect of our life. As a forward-looking tech company, we are increasingly aware of the role technology plays in improving efficiency and quality of our life. At the same time, we are also aware of the potential harm of its improper usage. For example, video products can record real, complete and clear images, therefore they hold great values in representing facts. Nevertheless, improper distribution, use and/or processing of video records may infringe on the privacy, legitimate rights and interests of others.

Committed to innovating technology for the good, we at EZVIZ hereby earnestly advocate that every user shall use video products properly and responsibly, thus to collectively create a positive environment where all related practices and usage comply with applicable laws and regulations, respect individuals' interests and rights, and promote social morality.

Here are EZVIZ's initiatives that we'd appreciate your attention:

1. Each individual possesses a reasonable expectation of privacy, and the use of video products should not be in conflict with such reasonable expectation. Therefore, a warning notice which clarifies the monitoring range should be displayed in a reasonable and effective manner, when installing video products in public areas. For non-public areas, the rights and interests of people involved shall be evaluated thoughtfully, including but not limited to, installing video products only after obtaining the consent of the stakeholders, and not installing highly-invisible video products without other's knowledge.

2. Video products objectively records footage of real activities within specific time and space. Users shall reasonably identify the people and rights involved in this scope in advance, to avoid any infringement of portrait, privacy or other legal rights of others while protecting themselves through video products. Notably, if you choose to enable the audio recording function on your camera, it will capture sounds, including conversations, within the monitoring range. We highly recommend a comprehensive assessment on the potential sound sources in the monitoring range, so as to fully understand the necessity and the reasonableness before you turn on the audio recording function.

3. Video products in use will consistently generate audio or visual data from real scenes –possibly including biometric information such as facial images – based on the user's selection of product features. Such data can be used or processed to use. Video products are only technological tools that do not and cannot humanly practice legal and moral standards to guide lawful and proper use of data. It is the methods and purposes of the people who control and use the generated data that make a difference. Therefore, data controllers shall not only strictly abide by applicable laws and regulations, but also fully respect non-obligatory rules including international conventions, moral standards, cultural norms, public order and local customs. Furthermore, we should always prioritize the protection of privacy and portrait rights, and other reasonable interests.

4. The video data continuously generated by video products carries the rights, values and other demands of various stakeholders. Thus, it is extremely crucial to ensure data security and shield the products from malicious intrusions. Every user and data controller shall, undertake all reasonable and necessary measures to maximize product and data security, avoiding data leakage, improper disclosure or misuse, including but not limited to, setting up access control, selecting a suitable network environment where video products are connected, establishing and constantly optimizing network security.

5. Video products have made great contributions to enhance the safety of our society, and we believe that they will continue to play a positive role in various aspects of our daily life. Any attempt to abuse these products to violate human rights or engage in unlawful activities contradicts the very essence of the value in tech innovation and product development. We encourage every user to establish your own methods and rules to evaluate and monitor the use of video products, so as to ensure that these products are always used properly, thoughtfully and with goodwill.