

COPYRIGHT © Hangzhou EZVIZ Software Co., Ltd.. ALL RIGHTS RESERVED.

Any and all information, including, among others, wordings, pictures, graphs are the properties of Hangzhou EZVIZ Software Co., Ltd. (hereinafter referred to as "EZVIZ"). This user manual (hereinafter referred to as "the Manual") cannot be reproduced, changed, translated, or distributed, partially or wholly, by any means, without the prior written permission of EZVIZ. Unless otherwise stipulated, EZVIZ does not make any warranties, guarantees or representations, express or implied, regarding to the Manual.

About this Manual

The Manual includes instructions for using and managing the product. Pictures, charts, images and all other information hereinafter are for description and explanation only. The information contained in the Manual is subject to change, without notice, due to firmware updates or other reasons. Please find the latest version in the EZVIZ™ website (<http://www.ezvizlife.com>).

Revision Record

New release – January, 2019

Trademarks Acknowledgement

EZVIZ™, ™, and other EZVIZ's trademarks and logos are the properties of EZVIZ in various jurisdictions. Other trademarks and logos mentioned below are the properties of their respective owners.

Legal Disclaimer

TO THE MAXIMUM EXTENT PERMITTED BY APPLICABLE LAW, THE PRODUCT DESCRIBED, WITH ITS HARDWARE, SOFTWARE AND FIRMWARE, IS PROVIDED "AS IS", WITH ALL FAULTS AND ERRORS, AND EZVIZ MAKES NO WARRANTIES, EXPRESS OR IMPLIED, INCLUDING WITHOUT LIMITATION, MERCHANTABILITY, SATISFACTORY QUALITY, FITNESS FOR A PARTICULAR PURPOSE, AND NON-INFRINGEMENT OF THIRD PARTY. IN NO EVENT WILL EZVIZ, ITS DIRECTORS, OFFICERS, EMPLOYEES, OR AGENTS BE LIABLE TO YOU FOR ANY SPECIAL, CONSEQUENTIAL, INCIDENTAL, OR INDIRECT DAMAGES, INCLUDING, AMONG OTHERS, DAMAGES FOR LOSS OF BUSINESS PROFITS, BUSINESS INTERRUPTION, OR LOSS OF DATA OR DOCUMENTATION, IN CONNECTION WITH THE USE OF THIS PRODUCT, EVEN IF EZVIZ HAS BEEN ADVISED OF THE POSSIBILITY OF SUCH DAMAGES.

TO THE MAXIMUM EXTENT PERMITTED BY APPLICABLE LAW, IN NO EVENT SHALL EZVIZ'S TOTAL LIABILITY FOR ALL DAMAGES EXCEED THE ORIGINAL PURCHASE PRICE OF THE PRODUCT.

EZVIZ DOES NOT UNDERTAKE ANY LIABILITY FOR PERSONAL INJURY OR PROPERTY DAMAGE AS THE RESULT OF PRODUCT INTERRUPTION OR SERVICE TERMINATION CAUSED BY: A) IMPROPER INSTALLATION OR USAGE OTHER THAN AS REQUESTED; B) THE PROTECTION OF NATIONAL OR PUBLIC INTERESTS; C) FORCE MAJEURE; D) YOURSELF OR THE THIRD PARTY, INCLUDING WITHOUT LIMITATION, USING ANY THIRD PARTY'S PRODUCTS, SOFTWARE, APPLICATIONS, AND AMONG OTHERS.

REGARDING TO THE PRODUCT WITH INTERNET ACCESS, THE USE OF PRODUCT SHALL BE WHOLLY AT YOUR OWN RISKS. EZVIZ SHALL NOT TAKE ANY RESPONSIBILITIES FOR ABNORMAL OPERATION, PRIVACY LEAKAGE OR OTHER DAMAGES RESULTING FROM CYBER ATTACK, HACKER ATTACK, VIRUS INSPECTION, OR OTHER INTERNET SECURITY RISKS; HOWEVER, EZVIZ WILL PROVIDE TIMELY TECHNICAL SUPPORT IF REQUIRED. SURVEILLANCE LAWS AND DATA PROTECTION LAWS VARY BY JURISDICTION. PLEASE CHECK ALL RELEVANT LAWS IN YOUR JURISDICTION BEFORE USING THIS PRODUCT IN ORDER TO ENSURE THAT YOUR USE CONFORMS TO THE APPLICABLE LAW. EZVIZ SHALL NOT BE LIABLE IN THE EVENT THAT THIS PRODUCT IS USED WITH ILLEGITIMATE PURPOSES.

IN THE EVENT OF ANY CONFLICTS BETWEEN THE ABOVE AND THE APPLICABLE LAW, THE LATTER PREVAILS.

Indholdet i pakken

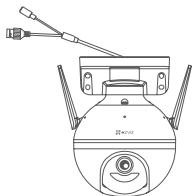

Kamera (x 1)



Strømadapter (x 1)



Skruesæt (x 1)

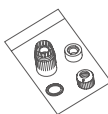

Sæt til vandsikring (x 1)



Boreskabelon (x 1)



Lovgivningsmæssige oplysninger (x 1)



Startvejledning (x 1)

Grundlæggende oplysninger

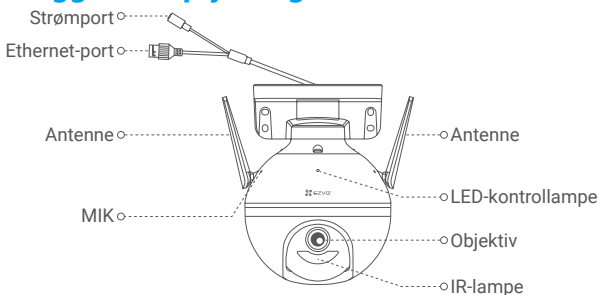

Navn

LED-kontrollampe

Beskrivelse

- Lyser konstant rødt: Kameraet starter op.
- Blinker langsomt rødt: Wi-fi-tilslutning mislykkedes.
- Blinker hurtigt rødt: Fejl på kamera (fx fejl på microSD-kort).
- Lyser konstant blå: Der vises livevideo i appen EZVIZ.
- Blinker langsomt blå: Kameraet fungerer korrekt.
- Blinker hurtigt blå: Kameraet er klar til wi-fi-tilslutning.

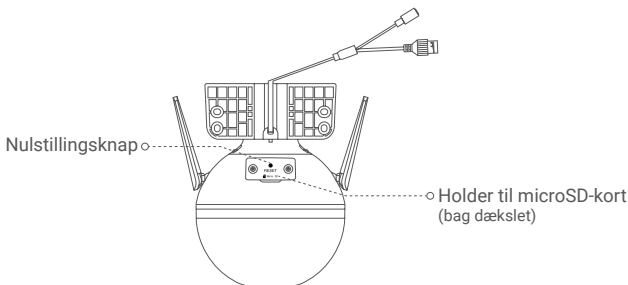

Navn

Nulstillingsknap

Beskrivelse

Hold nede i 5 sekunder for at genstarte og nulstille alle indstillinger til standard.

Konfiguration

1. Strømforsyning

Sæt strømkablet i kameraet, og sæt derefter strømadapteren i en stikkontakt som vist i figuren nedenfor.

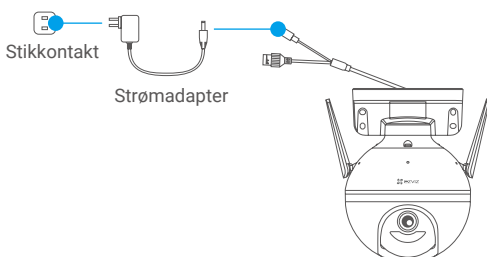

- i** LED-kontrollampen blinker hurtigt blå som tegn på, at kameraet er tændt og klar til wi-fi-konfiguration.

2. Opret forbindelse til internettet

1. Hent appen EZVIZ

- Slut din mobiltelefon til wi-fi-netværket.
- Hent og installér appen EZVIZ ved at søge efter "EZVIZ" i App Store eller Google Play Store™.
- Start appen, og opret en EZVIZ-brugerkonto.

2. Tilføjelse af kamera til EZVIZ

Mulighed 1: Trådløs tilslutning

- Log ind på din konto med appen EZVIZ.
- Tryk på "+" i øverste højre hjørne af startskærmen for at gå til siden Scan QR-kode.



- Scan QR-koden på omslaget af startvejledningen eller på kameraets hus.

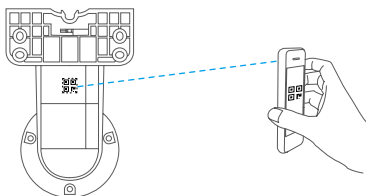

- Følg guiden i appen EZVIZ for at færdiggøre konfigurationen af wi-fi.

Mulighed 2: Kabeltilsluttet forbindelse

- Slut kameraet til LAN-porten på din router med et Ethernet-kabel (medfølger ikke i pakken).

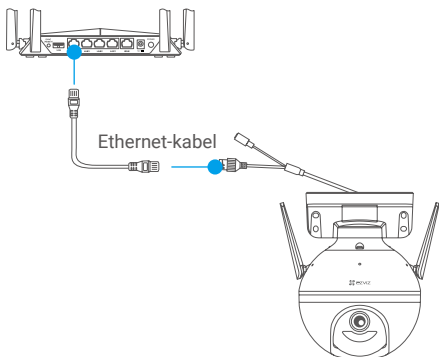

- Log ind på din konto med appen EZVIZ.
- Tryk på "+" i øverste højre hjørne af startskærmen for at gå til siden Scan QR-kode.

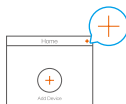

- Scan QR-koden på omslaget af startvejledningen eller på kameraets hus.

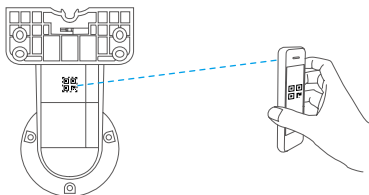

- Følg guiden for at føje kameraet til appen EZVIZ.

Installation

1. Isætning af microSD-kort (valgfrit)

- Drej kameraet mod uret.
- Fjern dækslet på kameraet.
- Isæt microSD-kortet (sælges separat) i kortholderen som vist i figuren herunder.
- Sæt dækslet på igen.

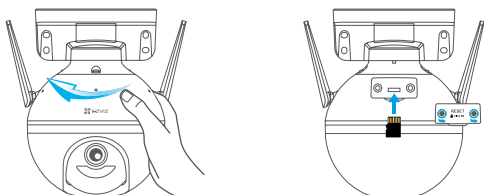

- Gå ind i appen EZVIZ, og tryk på **Storage Status (Lagerstatus)** på siden Device Settings (Enhedsindstillinger) for at se statussen for SD-kortet.
- Hvis hukommelseskortet viser status som **Uninitialized (Ikke formateret)**, skal du trykke på initialisér for at formatere kortet. Status ændres herefter til **Normal**, og der kan gemmes videoer på kortet.

2. Installation af kameraet

- Kontrollér, at væggen er stærk nok til at bære tre gange kameraets vægt.
- Kameraet kan monteres på væggen, i loftet eller på en stang.

Montering på væg/i loft

- Placér boreskabelonen på overfladen, hvor kameraet skal monteres.
- (Gælder kun cementvæg/-loft) Bor skruenhuller iht. skabelonen, og isæt fire rawlplugs.
- Brug fire metalskruer til at fastgøre kamerafoden.

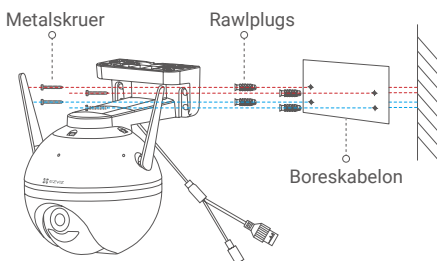

Fig. 1 Vægmontering

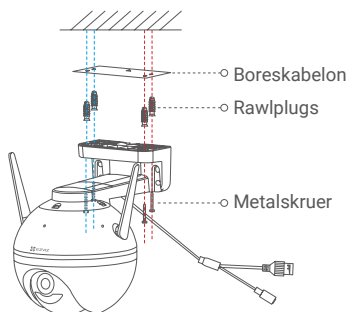
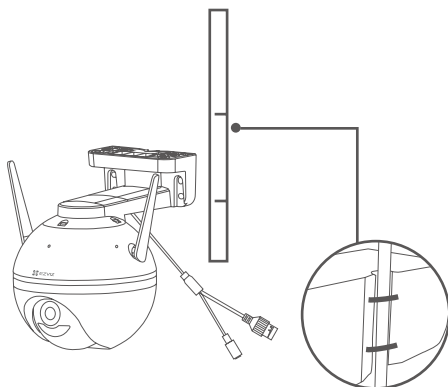

Fig. 2 Loftsmontage

Montering på pæl

Brug kabelbindere (medfølger ikke i pakken) til montering af kamerafoden på stangen.



3. Montering af sæt til vandsikring (valgfrit)

i Brug sættet til vandsikring, hvis kameraet installeres udendørs eller i fugtige omgivelser.

- Sæt pakningen i Ethernet-porten på kameraet.



- Før A-enden af Ethernet-kablet gennem møtrikken, pakningen og endedækslet.

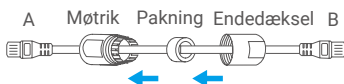

- Spænd møtrikken og endedækslet.



- Sæt A-enden i Ethernet-porten på kameraet, og spænd møtrikken.



- Sæt B-enden i LAN-porten på din router eller PoE-switch.

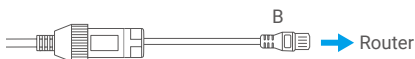

i Find nærmere oplysninger ved at besøge www.ezviz.eu.