

COPYRIGHT © Hangzhou EZVIZ Software Co., Ltd.. ALL RIGHTS RESERVED.

Any and all information, including, among others, wordings, pictures, graphs are the properties of Hangzhou EZVIZ Software Co., Ltd. (hereinafter referred to as "EZVIZ"). This user manual (hereinafter referred to as "the Manual") cannot be reproduced, changed, translated, or distributed, partially or wholly, by any means, without the prior written permission of EZVIZ. Unless otherwise stipulated, EZVIZ does not make any warranties, guarantees or representations, express or implied, regarding to the Manual.

About this Manual

The Manual includes instructions for using and managing the product. Pictures, charts, images and all other information hereinafter are for description and explanation only. The information contained in the Manual is subject to change, without notice, due to firmware updates or other reasons. Please find the latest version in the EZVIZ™ website (<http://www.ezvizlife.com>).

Revision Record

New release – January, 2019

Trademarks Acknowledgement

EZVIZ™, ™, and other EZVIZ's trademarks and logos are the properties of EZVIZ in various jurisdictions. Other trademarks and logos mentioned below are the properties of their respective owners.

Legal Disclaimer

TO THE MAXIMUM EXTENT PERMITTED BY APPLICABLE LAW, THE PRODUCT DESCRIBED, WITH ITS HARDWARE, SOFTWARE AND FIRMWARE, IS PROVIDED "AS IS", WITH ALL FAULTS AND ERRORS, AND EZVIZ MAKES NO WARRANTIES, EXPRESS OR IMPLIED, INCLUDING WITHOUT LIMITATION, MERCHANTABILITY, SATISFACTORY QUALITY, FITNESS FOR A PARTICULAR PURPOSE, AND NON-INFRINGEMENT OF THIRD PARTY. IN NO EVENT WILL EZVIZ, ITS DIRECTORS, OFFICERS, EMPLOYEES, OR AGENTS BE LIABLE TO YOU FOR ANY SPECIAL, CONSEQUENTIAL, INCIDENTAL, OR INDIRECT DAMAGES, INCLUDING, AMONG OTHERS, DAMAGES FOR LOSS OF BUSINESS PROFITS, BUSINESS INTERRUPTION, OR LOSS OF DATA OR DOCUMENTATION, IN CONNECTION WITH THE USE OF THIS PRODUCT, EVEN IF EZVIZ HAS BEEN ADVISED OF THE POSSIBILITY OF SUCH DAMAGES.

TO THE MAXIMUM EXTENT PERMITTED BY APPLICABLE LAW, IN NO EVENT SHALL EZVIZ'S TOTAL LIABILITY FOR ALL DAMAGES EXCEED THE ORIGINAL PURCHASE PRICE OF THE PRODUCT.

EZVIZ DOES NOT UNDERTAKE ANY LIABILITY FOR PERSONAL INJURY OR PROPERTY DAMAGE AS THE RESULT OF PRODUCT INTERRUPTION OR SERVICE TERMINATION CAUSED BY: A) IMPROPER INSTALLATION OR USAGE OTHER THAN AS REQUESTED; B) THE PROTECTION OF NATIONAL OR PUBLIC INTERESTS; C) FORCE MAJEURE; D) YOURSELF OR THE THIRD PARTY, INCLUDING WITHOUT LIMITATION, USING ANY THIRD PARTY'S PRODUCTS, SOFTWARE, APPLICATIONS, AND AMONG OTHERS.

REGARDING TO THE PRODUCT WITH INTERNET ACCESS, THE USE OF PRODUCT SHALL BE WHOLLY AT YOUR OWN RISKS. EZVIZ SHALL NOT TAKE ANY RESPONSIBILITIES FOR ABNORMAL OPERATION, PRIVACY LEAKAGE OR OTHER DAMAGES RESULTING FROM CYBER ATTACK, HACKER ATTACK, VIRUS INSPECTION, OR OTHER INTERNET SECURITY RISKS; HOWEVER, EZVIZ WILL PROVIDE TIMELY TECHNICAL SUPPORT IF REQUIRED. SURVEILLANCE LAWS AND DATA PROTECTION LAWS VARY BY JURISDICTION. PLEASE CHECK ALL RELEVANT LAWS IN YOUR JURISDICTION BEFORE USING THIS PRODUCT IN ORDER TO ENSURE THAT YOUR USE CONFORMS TO THE APPLICABLE LAW. EZVIZ SHALL NOT BE LIABLE IN THE EVENT THAT THIS PRODUCT IS USED WITH ILLEGITIMATE PURPOSES.

IN THE EVENT OF ANY CONFLICTS BETWEEN THE ABOVE AND THE APPLICABLE LAW, THE LATTER PREVAILS.

Pakkens innhold

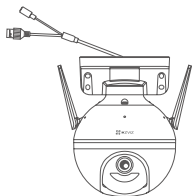

Kamera (x1)



Strømadapter (x1)



Skruesett (x1)

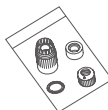

Vannbeskyttelsessett (x1)



Monteringsmal (x1)



Regulatorisk informasjon (x1)



Hurtigstartveiledning (x1)

Grunnleggende funksjoner

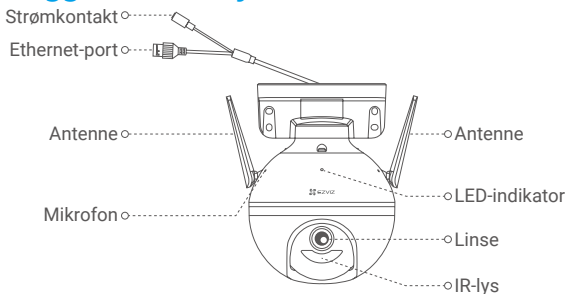

Navn

LED-indikator

Beskrivelse

- Rød – fast: Kameraet starter opp.
- Blinker sakte rødt: Wi-Fi-tilkobling mislyktes.
- Blinker raskt rødt: Kameraunntak (f.eks. MicroSD-kortfeil).
- Blå – fast: Direktevist video vises i EZVIZ-appen.
- Blinker sakte blått: Kameraet fungerer normalt.
- Blinker raskt blått: Kameraet er klart for Wi-Fi-tilkobling.

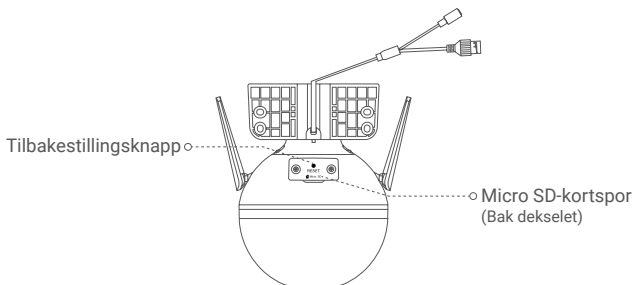

Navn

Tilbakestillingsknapp

Beskrivelse

Hold inne i 5 sekunder for å tilbakestille alle parametrene til standard.

Oppsett

1. Slå på

Koble strømledningen til kameraet, og sett deretter strømadapteren i en stikkontakt som vist på bildet nedenfor.

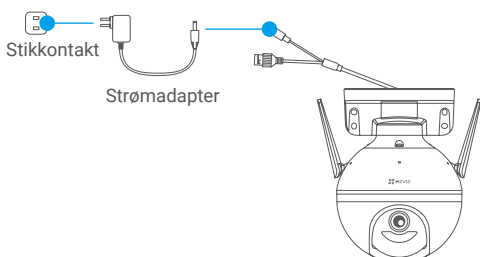

- i** Når LED-indikatoren begynner å blinke raskt i blått, indikerer det at kameraet er skrudd på og klart for konfigurering av Wi-Fi.

2. Koble til Internett

1. Skaff deg EZVIZ-appen

- Koble mobiltelefonen til et Wi-Fi-nettverk.
- Last ned og installer EZVIZ-appen ved å søke etter «EZVIZ» i App Store eller Google Play-butikken™.
- Start appen og registrer en EZVIZ-brukerkonto.

2. Legg til kamera i EZVIZ

Alternativ 1: Trådløs forbindelse

- Logg inn på brukerkontoen din på EZVIZ-appen.
- Fra startsidene trykker du på «+» i øverste høyre hjørne for å gå til siden for skanning av QR-koden.



- Skann QR-koden på omslaget til hurtigstartguiden eller på selve kameraet.

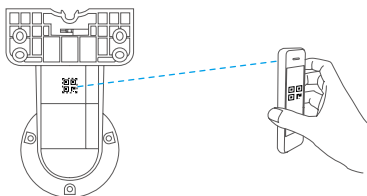

- Følg hjelpeprogrammet til EZVIZ-appen for å fullføre Wi-Fi-konfigureringen.

Alternativ 2: Kablet forbindelse

- Koble kameraet til LAN-porten på ruterne med en Ethernet-kabel (følger ikke med i pakken).

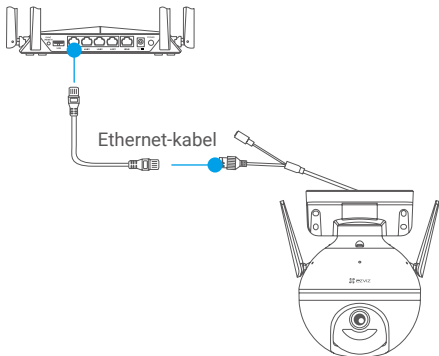

- Logg inn på brukerkontoen din på EZVIZ-appen.
- Fra startsidene trykker du på «+» i øverste høyre hjørne for å gå til siden for skanning av QR-koden.

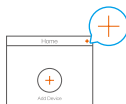

- Skann QR-koden på omslaget til hurtigstartguiden eller på selve kameraet.

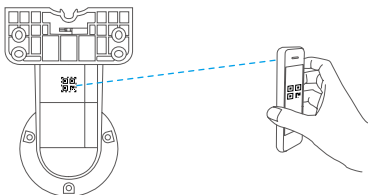

- Følg veiviseren for å legge til kameraet i EZVIZ-appen.

Installasjon

1. Sett inn Micro SD-kortet (valgfritt)

- Drei kameraet mot klokken.
- Fjern dekselet på kameraet.
- Sett Micro SD-kortet (selges separat) inn i kortsporet som vist i figuren nedenfor.
- Sett på dekselet igjen.

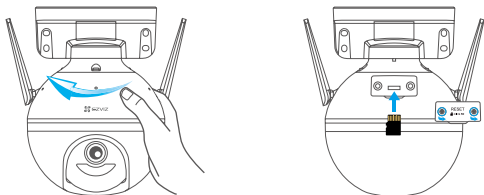

- For å sjekke status på SD-kortet, trykker du på «Storage Status» (**lagringsstatus**) i menyen for Device Settings (Enhetsinnstillinger) i EZVIZ-appen.
- Hvis statusen for minnekortet vises som «Uninitialized» (**ikke initialisert**), trykker du for å initialisere det. Statusen endres deretter til «Normal» og den kan lagre videoer.

2. Montere kameraet

- Forsikre deg om at veggen er sterk nok til å tåle tre ganger vekten av kameraet.
- Kameraet kan monteres horisontalt, i taket eller på en stang.

Montering på vegg / i tak

- Plasser monteringsmalen på overflaten du har valgt for å montere kameraet.
- (Kun for vegger/tak av betong) Bor skruerull i henhold til malen og sett inn fire ekspansjonsbolter e.l.
- Bruk fire metallskruer til å feste kamerasokkelen.

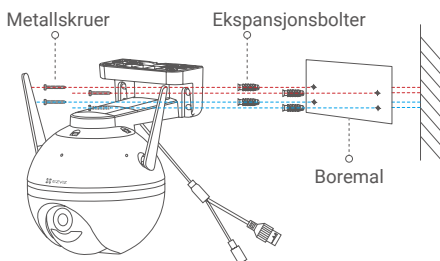

Fig.1 Veggmontering

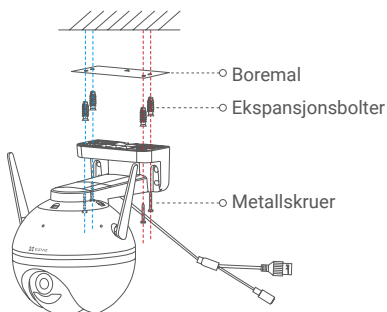
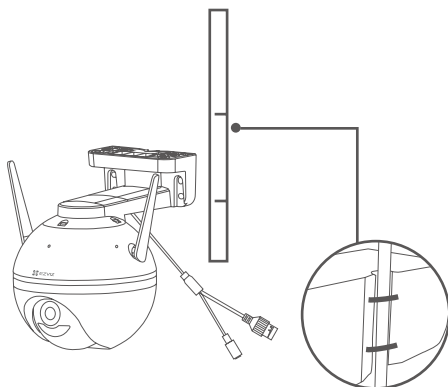

Fig.2 Takmontering

Montering på stang

Bruk kabelstripsen (følger ikke med i pakken) til å feste kamerasokkelen til stangen.



3. Installer vannbeskyttelsessettet (valgfritt)

i Hvis kameraet er montert utendørs eller i fuktige omgivelser, bør du bruke vannbeskyttelsessettet.

- Sett inn pakningen i kameraets Ethernet-port.



- Før Ethernet-kabelens side A gjennom startstykket, pakningen og endestykket.

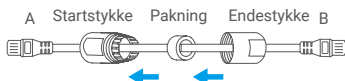

- Stram til startstykket og endestykket.



- Sett inn side A i kameraets Ethernet-port, og stram til startstykket.



- Koble B-siden til LAN-porten på ruter eller PoE-svitsjen.

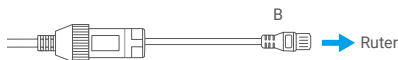

i Besøk www.ezviz.eu hvis du vil ha mer informasjon.