

COPYRIGHT © Hangzhou EZVIZ Software Co., Ltd.. ALL RIGHTS RESERVED.

Any and all information, including, among others, wordings, pictures, graphs are the properties of Hangzhou EZVIZ Software Co., Ltd. (hereinafter referred to as "EZVIZ"). This user manual (hereinafter referred to as "the Manual") cannot be reproduced, changed, translated, or distributed, partially or wholly, by any means, without the prior written permission of EZVIZ. Unless otherwise stipulated, EZVIZ does not make any warranties, guarantees or representations, express or implied, regarding to the Manual.

### **About this Manual**

The Manual includes instructions for using and managing the product. Pictures, charts, images and all other information hereinafter are for description and explanation only. The information contained in the Manual is subject to change, without notice, due to firmware updates or other reasons. Please find the latest version in the EZVIZ™ website (<http://www.ezvizlife.com>).

### **Revision Record**

New release – January, 2019

### **Trademarks Acknowledgement**

EZVIZ™, ™, and other EZVIZ's trademarks and logos are the properties of EZVIZ in various jurisdictions. Other trademarks and logos mentioned below are the properties of their respective owners.

### **Legal Disclaimer**

TO THE MAXIMUM EXTENT PERMITTED BY APPLICABLE LAW, THE PRODUCT DESCRIBED, WITH ITS HARDWARE, SOFTWARE AND FIRMWARE, IS PROVIDED "AS IS", WITH ALL FAULTS AND ERRORS, AND EZVIZ MAKES NO WARRANTIES, EXPRESS OR IMPLIED, INCLUDING WITHOUT LIMITATION, MERCHANTABILITY, SATISFACTORY QUALITY, FITNESS FOR A PARTICULAR PURPOSE, AND NON-INFRINGEMENT OF THIRD PARTY. IN NO EVENT WILL EZVIZ, ITS DIRECTORS, OFFICERS, EMPLOYEES, OR AGENTS BE LIABLE TO YOU FOR ANY SPECIAL, CONSEQUENTIAL, INCIDENTAL, OR INDIRECT DAMAGES, INCLUDING, AMONG OTHERS, DAMAGES FOR LOSS OF BUSINESS PROFITS, BUSINESS INTERRUPTION, OR LOSS OF DATA OR DOCUMENTATION, IN CONNECTION WITH THE USE OF THIS PRODUCT, EVEN IF EZVIZ HAS BEEN ADVISED OF THE POSSIBILITY OF SUCH DAMAGES.

TO THE MAXIMUM EXTENT PERMITTED BY APPLICABLE LAW, IN NO EVENT SHALL EZVIZ'S TOTAL LIABILITY FOR ALL DAMAGES EXCEED THE ORIGINAL PURCHASE PRICE OF THE PRODUCT.

EZVIZ DOES NOT UNDERTAKE ANY LIABILITY FOR PERSONAL INJURY OR PROPERTY DAMAGE AS THE RESULT OF PRODUCT INTERRUPTION OR SERVICE TERMINATION CAUSED BY: A) IMPROPER INSTALLATION OR USAGE OTHER THAN AS REQUESTED; B) THE PROTECTION OF NATIONAL OR PUBLIC INTERESTS; C) FORCE MAJEURE; D) YOURSELF OR THE THIRD PARTY, INCLUDING WITHOUT LIMITATION, USING ANY THIRD PARTY'S PRODUCTS, SOFTWARE, APPLICATIONS, AND AMONG OTHERS.

REGARDING TO THE PRODUCT WITH INTERNET ACCESS, THE USE OF PRODUCT SHALL BE WHOLLY AT YOUR OWN RISKS. EZVIZ SHALL NOT TAKE ANY RESPONSIBILITIES FOR ABNORMAL OPERATION, PRIVACY LEAKAGE OR OTHER DAMAGES RESULTING FROM CYBER ATTACK, HACKER ATTACK, VIRUS INSPECTION, OR OTHER INTERNET SECURITY RISKS; HOWEVER, EZVIZ WILL PROVIDE TIMELY TECHNICAL SUPPORT IF REQUIRED. SURVEILLANCE LAWS AND DATA PROTECTION LAWS VARY BY JURISDICTION. PLEASE CHECK ALL RELEVANT LAWS IN YOUR JURISDICTION BEFORE USING THIS PRODUCT IN ORDER TO ENSURE THAT YOUR USE CONFORMS TO THE APPLICABLE LAW. EZVIZ SHALL NOT BE LIABLE IN THE EVENT THAT THIS PRODUCT IS USED WITH ILLEGITIMATE PURPOSES.

IN THE EVENT OF ANY CONFLICTS BETWEEN THE ABOVE AND THE APPLICABLE LAW, THE LATTER PREVAILS.

# Conteúdo da embalagem

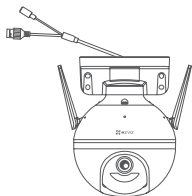

1 Câmera



1 Adaptador de energia



1 Kit de parafusos

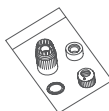

1 Kit à prova d'água



1 Modelo de furos



1 informações regulamentares



1 Guia de início rápido

## Elementos básicos

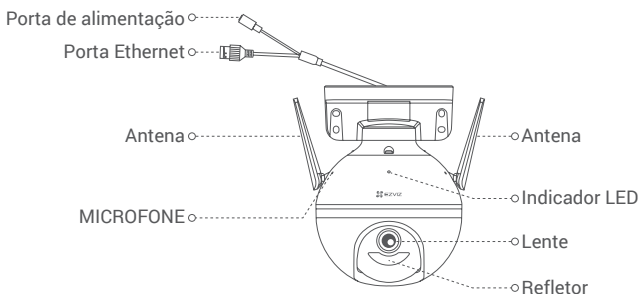

Nome	Descrição
Indicador LED	<ul style="list-style-type: none"><li>• Vermelho fixo: a câmera está iniciando.</li><li>• Vermelho piscando lentamente: a conexão Wi-Fi falhou.</li><li>• Vermelho piscando rapidamente: Exceção da câmera (p. ex., erro do cartão Micro SD).</li><li>• Azul fixo: vídeo sendo visto ao vivo no aplicativo EZVIZ.</li><li>• Azul piscando lentamente: a câmera está funcionando adequadamente.</li><li>• Azul piscando rapidamente: a câmera está pronta para conexão Wi-Fi.</li></ul>

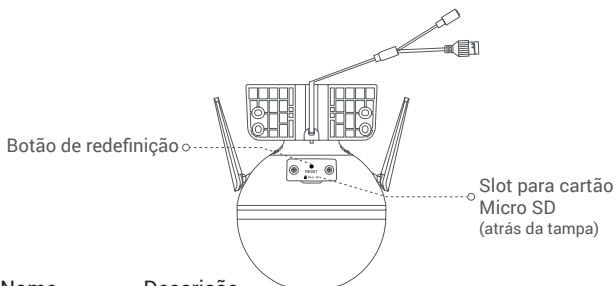

Nome	Descrição
------	-----------

## Configuração

### 1. Ativação

Conecte o cabo de alimentação à câmera e, em seguida, conecte o adaptador de energia a uma tomada, como mostrado na figura abaixo.

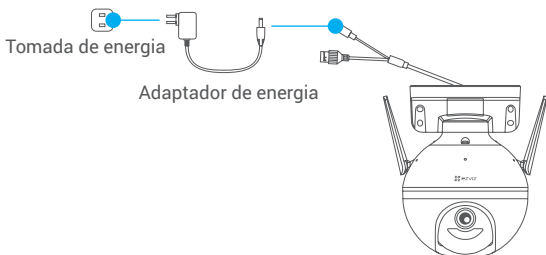

- i** O indicador LED piscando rapidamente em azul indica que a câmera está ligada e pronta para a configuração Wi-Fi.

### 2. Conexão com a internet

#### 1. Baixar o aplicativo EZVIZ

- Conecte seu celular à rede Wi-Fi.
- Baixe e instale o aplicativo EZVIZ pesquisando por "EZVIZ" na App Store ou na Google Play Store™.
- Abra o aplicativo e crie uma conta de usuário do EZVIZ.

#### 2. Adicionar uma câmera ao EZVIZ

##### Opção 1: Conexão sem fio

- Faça login na sua conta usando o aplicativo EZVIZ.
- Na tela inicial, toque em "+" no canto superior direito para acessar a interface Ler código QR.



- Leia o código QR na capa do Guia de início rápido ou no corpo da câmera.

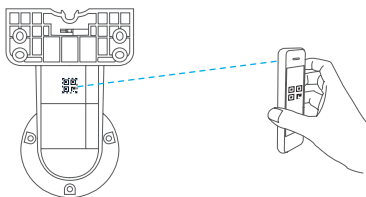

- Siga as instruções do assistente do aplicativo EZVIZ para concluir a configuração do Wi-Fi.

##### Opção 2: Conexão com fio

- Conecte a câmera a uma porta LAN do seu roteador com o cabo Ethernet (não incluído no pacote).

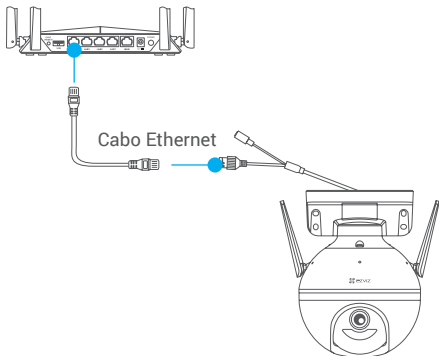

- Faça login na sua conta usando o aplicativo EZVIZ.
- Na tela inicial, toque em "+" no canto superior direito para acessar a interface Ler código QR.



- Leia o código QR na capa do Guia de início rápido ou no corpo da câmera.

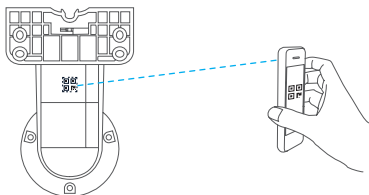

- Siga o assistente para adicionar a câmera ao aplicativo EZVIZ.

## Instalação

### 1. Instalar o cartão MicroSD (opcional)

- Gire a câmera no sentido anti-horário.
- Retire a tampa da câmera.
- Insira o cartão MicroSD (vendido separadamente) na entrada de cartão, como mostrado na figura abaixo.
- Coloque a tampa novamente.

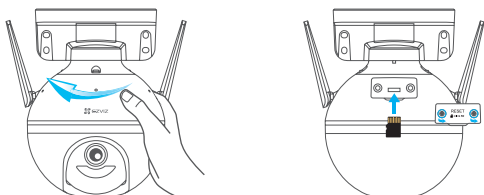

- No aplicativo EZVIZ, toque em **Storage Status (Status de armazenamento)** na interface Device Settings (Configurações do dispositivo) para verificar o status do cartão SD.
- Se o status do cartão de memória for exibido como **Unitialized (Não inicializado)**, toque para inicializá-lo. O status mudará para **Normal** e o cartão poderá armazenar vídeos.

## 2. Instalar a câmera

- Verifique se a parede/teto é resistente o suficiente para suportar três vezes o peso da câmera.
- A câmera pode ser montada na parede, teto ou poste.

### Montagem na parede/teto

- Coloque o gabarito de furos na superfície escolhida para montar a câmera.
- (Apenas para parede/teto de cimento) Faça os furos dos parafusos de acordo com o modelo e insira quatro buchas.
- Use quatro parafusos de metal para fixar a base da câmera.

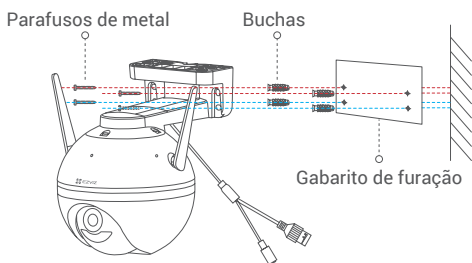

Fig. 1 Montagem na parede

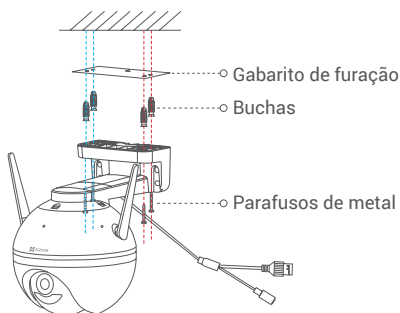
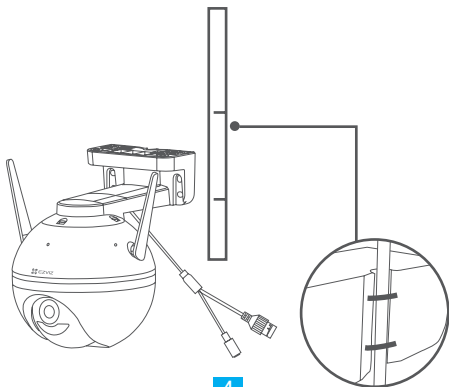

Fig. 2 Montagem no teto

### Montagem em poste

Use a braçadeira de cabo (não incluída no pacote) para fixar a base da câmera no poste.



### 3. Instale o kit à prova d'água (opcional)

**i** Se a câmera for instalada ao ar livre ou em um ambiente úmido, use o kit à prova d'água.

- Insira a junta na porta Ethernet da câmera.



- Passe o lado A do cabo Ethernet pela porca, pela junta e pela tampa.

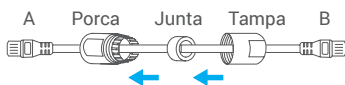

- Aperte a porca e a tampa.



- Insira o lado A na porta Ethernet da câmera e aperte a porca.



- Conecte o lado B com a porta LAN do roteador ou chave PoE.



**i** Para informações detalhadas, consulte [www.ezvizlife.com](http://www.ezvizlife.com).