



C3A+W2D
User Manual

User Manual

COPYRIGHT © Hangzhou EZVIZ Software Co., Ltd. ALL RIGHTS RESERVED.

Any and all information, including, among others, wordings, pictures, graphs are the properties of Hangzhou EZVIZ Software Co., Ltd. (hereinafter referred to be “EZVIZ”). This user manual (hereinafter referred to be “the Manual”) cannot be reproduced, changed, translated, or distributed, partially or wholly, by any means, without the prior written permission of EZVIZ. Unless otherwise stipulated, EZVIZ does not make any warranties, guarantees or representations, express or implied, regarding to the Manual.

About this Manual

The Manual includes instructions for using and managing the product. Pictures, charts, images and all other information hereinafter are for description and explanation only. The information contained in the Manual is subject to change, without notice, due to firmware updates or other reasons. Please find the latest version in the **EZVIZ™** website (<http://www.ezvizlife.com>).

Revision Record

New release – January, 2019

Trademarks Acknowledgement

EZVIZ™, ™, and other EZVIZ’s trademarks and logos are the properties of EZVIZ in various jurisdictions. Other trademarks and logos mentioned below are the properties of their respective owners.

Legal Disclaimer

TO THE MAXIMUM EXTENT PERMITTED BY APPLICABLE LAW, THE PRODUCT DESCRIBED, WITH ITS HARDWARE, SOFTWARE AND FIRMWARE, IS PROVIDED “AS IS”, WITH ALL FAULTS AND ERRORS, AND EZVIZ MAKES NO WARRANTIES, EXPRESS OR IMPLIED, INCLUDING WITHOUT LIMITATION, MERCHANTABILITY, SATISFACTORY QUALITY, FITNESS FOR A PARTICULAR PURPOSE, AND NON-INFRINGEMENT OF THIRD PARTY. IN NO EVENT WILL EZVIZ, ITS DIRECTORS, OFFICERS, EMPLOYEES, OR AGENTS BE LIABLE TO YOU FOR ANY SPECIAL, CONSEQUENTIAL, INCIDENTAL, OR INDIRECT DAMAGES, INCLUDING, AMONG OTHERS, DAMAGES FOR LOSS OF BUSINESS PROFITS, BUSINESS INTERRUPTION, OR LOSS OF DATA OR DOCUMENTATION, IN CONNECTION WITH THE USE OF THIS PRODUCT, EVEN IF EZVIZ HAS BEEN ADVISED OF THE POSSIBILITY OF SUCH DAMAGES.

TO THE MAXIMUM EXTENT PERMITTED BY APPLICABLE LAW, IN NO EVENT SHALL EZVIZ’S TOTAL LIABILITY FOR ALL DAMAGES EXCEED THE ORIGINAL PURCHASE PRICE OF THE PRODUCT.

EZVIZ DOES NOT UNDERTAKE ANY LIABILITY FOR PERSONAL INJURY OR PROPERTY DAMAGE AS THE RESULT OF PRODUCT INTERRUPTION OR SERVICE TERMINATION CAUSED BY: A) IMPROPER INSTALLATION OR USAGE OTHER THAN AS REQUESTED; B) THE

PROTECTION OF NATIONAL OR PUBLIC INTERESTS; C) FORCE MAJEURE; D) YOURSELF OR THE THIRD PARTY, INCLUDING WITHOUT LIMITATION, USING ANY THIRD PARTY'S PRODUCTS, SOFTWARE, APPLICATIONS, AND AMONG OTHERS.

REGARDING TO THE PRODUCT WITH INTERNET ACCESS, THE USE OF PRODUCT SHALL BE WHOLLY AT YOUR OWN RISKS. EZVIZ SHALL NOT TAKE ANY RESPONSIBILITIES FOR ABNORMAL OPERATION, PRIVACY LEAKAGE OR OTHER DAMAGES RESULTING FROM CYBER ATTACK, HACKER ATTACK, VIRUS INSPECTION, OR OTHER INTERNET SECURITY RISKS; HOWEVER, EZVIZ WILL PROVIDE TIMELY TECHNICAL SUPPORT IF REQUIRED.

SURVEILLANCE LAWS AND DATA PROTECTION LAWS VARY BY JURISDICTION. PLEASE CHECK ALL RELEVANT LAWS IN YOUR JURISDICTION BEFORE USING THIS PRODUCT IN ORDER TO ENSURE THAT YOUR USE CONFORMS TO THE APPLICABLE LAW. EZVIZ SHALL NOT BE LIABLE IN THE EVENT THAT THIS PRODUCT IS USED WITH ILLEGITIMATE PURPOSES.

IN THE EVENT OF ANY CONFLICTS BETWEEN THE ABOVE AND THE APPLICABLE LAW, THE LATTER PREVAILS.

Regulatory Information

FCC Information

This device complies with Part 15 of the FCC Rules. Operation is subject to the following two conditions:

- (1) This device may not cause harmful interference, and
- (2) This device must accept any interference received, including interference that may cause undesired operation.

Note: This product has been tested and found to comply with the limits for a Class B digital device, pursuant to Part 15 of the FCC Rules. These limits are designed to provide reasonable protection against harmful interference in a residential installation. This product generates, uses, and can radiate radio frequency energy and, if not installed and used in accordance with the instructions, may cause harmful interference to radio communications. However, there is no guarantee that interference will not occur in a particular installation. If this product does cause harmful interference to radio or television reception, which can be determined by turning the equipment off and on, the user is encouraged to try to correct the interference by one or more of the following measures:

- Reorient or relocate the receiving antenna.
- Increase the separation between the equipment and receiver.
- Connect the equipment into an outlet on a circuit different from that to which the receiver is connected.
- Consult the dealer or an experienced radio/TV technician for help.

Please take attention that changes or modification not expressly approved by the party responsible for compliance could void the user's authority to operate the equipment.

This equipment should be installed and operated with a minimum distance 20cm between the radiator and your body.

This device complies with Industry Canada licence-exempt RSS standard(s). Operation is subject to the following two conditions:

- (1) This device may not cause interference, and
- (2) This device must accept any interference, including interference that may cause undesired operation of the device.

Under Industry Canada regulations, this radio transmitter may only operate using an antenna of a type and maximum (or lesser) gain approved for the transmitter by Industry Canada. To reduce potential radio interference to other users, the antenna type and its gain should be so chosen that the equivalent isotropically radiated power (e.i.r.p.) is not more than that necessary for successful communication.



EU Conformity Statement

This product and - if applicable - the supplied accessories too are marked with "CE" and comply therefore with the applicable harmonized European standards listed under the Radio Equipment Directive 2014/53/EU, the EMC Directive 2014/30/EU, the RoHS Directive 2011/65/EU.



2012/19/EU (WEEE directive): Products marked with this symbol cannot be disposed of as unsorted municipal waste in the European Union. For proper recycling, return this product to your local supplier upon the purchase of equivalent new equipment, or dispose of it at designated collection points.

For more information see: www.recyclethis.info.



2006/66/EC and its amendment 2013/56/EU (battery directive): This product contains a battery that cannot be disposed of as unsorted municipal waste in the European Union. See the product documentation for specific battery information. The battery is marked with this symbol, which may include lettering to indicate cadmium (Cd), lead (Pb), or mercury (Hg). For proper recycling, return the battery to your supplier or to a designated collection point.

For more information see: www.recyclethis.info.



Гарантийный срок-1 год

Срок службы-3 года

Производитель:Ханджоу Хиквижн Диджитал

Технолоджи(Китай)

Импортер-поставщик в России: ЗАО "Хиквижн"

Импортер-поставщик в Республике Беларусь:ООО "Торговый Дом "АВАНТ-ТЕХНО"

Сайт:www.ezviz.ru

Industry Canada ICES-003 Compliance

This device meets the CAN ICES-3 (B)/NMB-3(B) standards requirements.

EC DECLARATION OF CONFORMITY

Hereby, Hangzhou EZVIZ Software Co., Ltd. declares that the radio equipment type [CS-C3A, CS-W2D] is in compliance with Directive 2014/53/EU.

The full text of the EC DECLARATION OF CONFORMITY is available at the following web link:

<http://www.ezvizlife.com/declaration-of-conformity>.

Safety Instruction

Cautions: THE PRODUCT IS BUILT IN A REPLACEABLE BATTERY. RISK OF EXPLOSION IF BATTERY IS REPLACED BY AN INCORRECT TYPE. DISPOSE OF USED BATTERIES ACCORDING TO THE INSTRUCTIONS.

Due to the product shape and dimension, the name and address of the importer/manufacture are printed on the package.

Customer Service

For more information, please visit www.ezvizlife.com.

Need help? Please visit "www.ezvizlife.com/inter/page/contact-us" for our local contact details.

TABLE OF CONTENTS

CHAPTER 1	OVERVIEW	1
1.1	BRIEF INTRODUCTION	1
1.1.1	<i>The Appearance of the Device</i>	1
CHAPTER 2	POWER ON YOUR DEVICE	2
2.1	HOW TO CHARGE THE BATTERY	2
2.1.1	<i>Charging Station (Sold Separately)</i>	2
2.1.2	<i>Power Adapter</i>	3
2.1.3	<i>Solar Panel (Sold Separately)</i>	4
CHAPTER 3	CONNECT YOUR BASE STATION TO THE INTERNET	5
CHAPTER 4	GET THE EZVIZ APP	6
CHAPTER 5	USE THE EZVIZ APP FOR INSTALLATION AND SETUP	7
CHAPTER 6	PLACE OR MOUNT YOUR CAMERA	12
6.1	THE WALL MOUNTING	12
6.1.1	<i>Option 1: Secure the metal plate with screws</i>	12
6.1.2	<i>Option 2: Secure the metal plate with foam sticker</i>	12
6.2	FIND A GOOD SPOT FOR YOUR CAMERA	13
6.3	POSITION YOUR CAMERA TO OPTIMIZE ITS FIELD OF VIEW	13
CHAPTER 7	LED INDICATOR GUIDE	15
7.1	BASE STATION LED INDICATOR	15
7.2	CAMERA LED INDICATOR	16
CHAPTER 8	USE A MICRO SD CARD	17
8.1	INSERT A MICRO SD CARD	17
8.2	INITIALIZE A MICRO SD CARD IN THE EZVIZ APP	18
8.3	VIEW THE MICRO SD CARD STATUS FOR A CAMERA	18
CHAPTER 9	VIEW YOUR CAMERA	20
CHAPTER 10	TROUBLESHOOTING	22

Chapter 1 Overview

1.1 Brief Introduction

You can use your camera wirelessly, powered by the battery. Also, you can use it indoors with an AC power outlet connected, or use it outdoors with a solar panel. Once motion is detected by the camera, you can check the messages in the APP through the Wi-Fi linked to the base station.

1.1.1 The Appearance of the Device

The appearance of the device is shown below.



Figure 1-1 Appearance

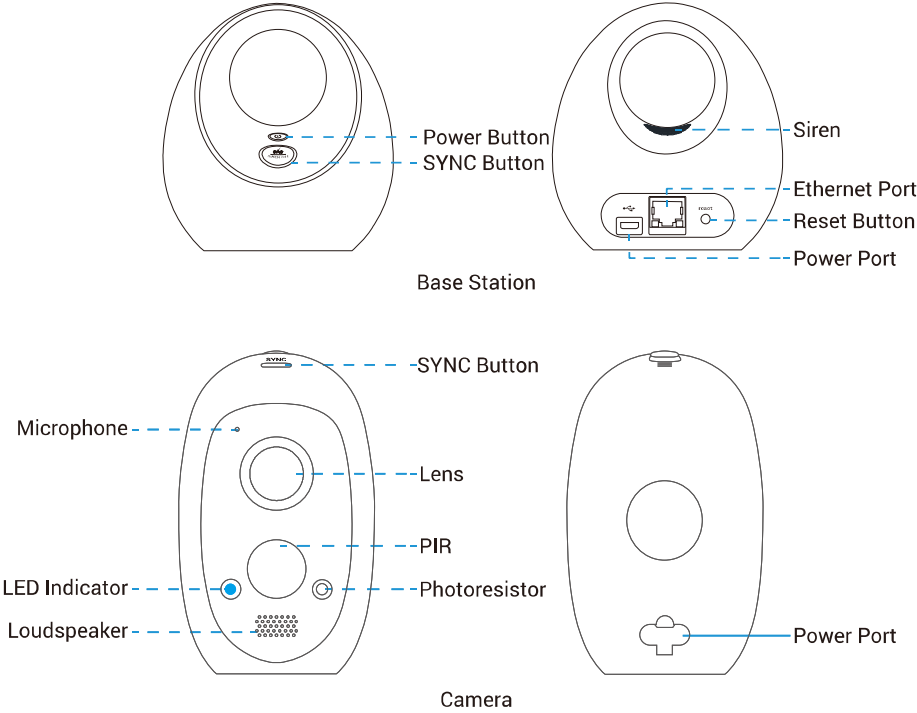

Figure 1-2 Appearance Instruction

Chapter 2 Power on Your Device

Your camera comes with accessories that you can use to create a custom security system that meets your individual needs.

Notes:

- For wireless use: Before you use your camera wirelessly, we recommend that you charge the battery, referring to **2.1 How to Charge the Battery**.
- For wired use:
 1. Indoor: Connect the power adapter to an indoor electrical outlet, referring to **2.1.2 Power Adapter**.
 2. Outdoor: If you want to install your camera outdoors, use the solar panel (sold separately), referring to **2.1.3 Solar Panel (Sold Separately)**.

2.1 How to Charge the Battery

2.1.1 Charging Station (Sold Separately)

You can use the charging station (sold separately) to charge the battery.

Steps:

1. Insert the battery into one of the battery slots.

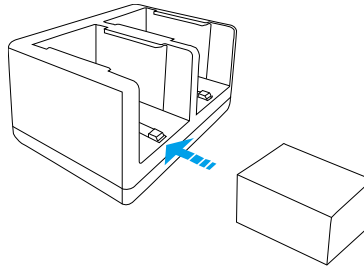

Figure 2-1 Insert the Battery

2. Connect the power cable to the power adapter.
3. Connect the charger with an indoor electrical outlet via power adapter (5V 2A).

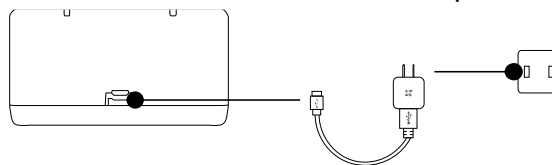

Figure 2-2 Wiring

Note:

When the battery is fully charged, the LED indicator of charging station turns green.

4. After charging the battery, hold on the clasps until you pull out the battery.

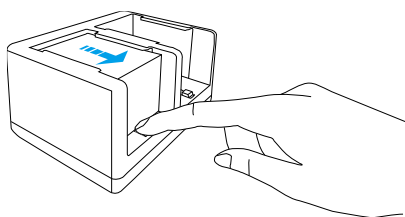

Figure 2-3 Pull out the Battery

2.1.2 Power Adapter

You can use the power adapter to charge the battery.

1. Install the Battery

Steps:

- (1) Unlock the battery compartment by pressing and holding the latch, at the same gently pull back the battery cover to open the compartment.
- (2) Pull the battery buckle upwards and insert the battery.
- (3) Insert a micro SD card into the micro SD card slot if needed (See [8.1 Insert a Micro SD Card](#)).
- (4) Close the battery cover.

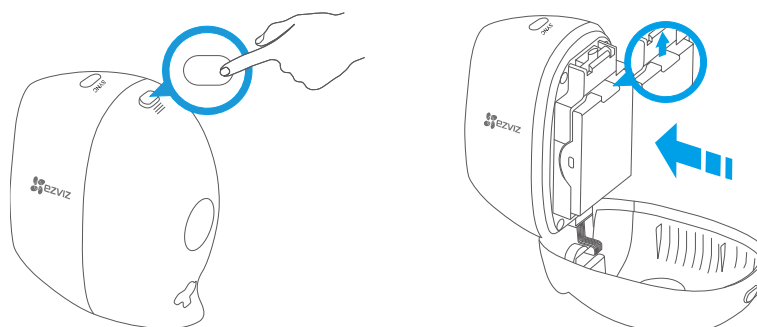

Figure 2-4 Install the Battery

Note:

Write down the verification code located on the battery, you are required to input it when you live view or play back the video.

2. Charge Your Camera Battery

Steps:

- (1) If the camera is outdoor, bring it in to charge the battery.
- (2) Connect the power cable to the power adapter.
- (3) Connect the camera with an indoor electrical outlet via power adapter (5V 2A).

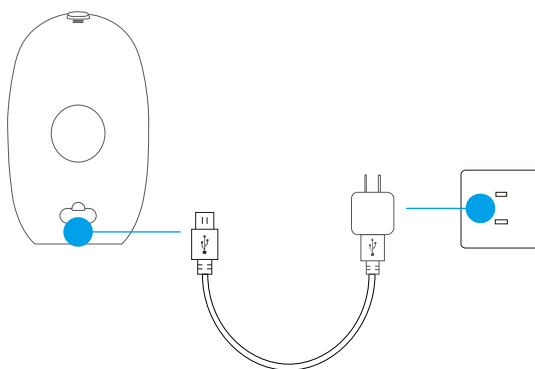

Figure 2-5 Charge the Battery

Note:

The camera LED indicator status is shown as below.

- Battery charging: Slow-flashing red.
- Battery fully charged: Off.

2.1.3 Solar Panel (Sold Separately)

You can use the solar panel (sold separately) to charge the battery.

Steps:

1. Install the battery (See [Install the Battery](#) in [2.1.2 Power Adapter](#)).
2. Connect the camera to the solar panel.

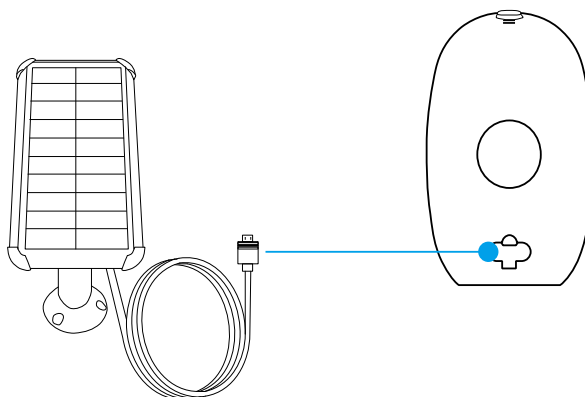

Figure 2-6 Use Solar Panel to Charge the Battery

Notes:

When the battery is fully charged, the camera LED indicator turns solid blue.

- As an alternative charging equipment, the power amount generated by this solar panel may be affected by its actual surrounding environment, mainly the intensity of sunlight and the time length of illumination. If the battery camera is running out of power soon, you are recommended to charge the battery by charging station or power adapter, as the solar panel alone cannot ensure the camera normal working status.

The camera LED indicator status is shown as below.

- Battery charging: Slow-flashing red.
- Battery fully charged: Off.

Chapter 3 Connect Your Base Station to the Internet

The base station connects to your home network and allows you to view your camera videos from anywhere.

1. Connect the power cable to the power adapter.
2. Connect the power adaptor to an indoor electrical outlet (5V 2A).

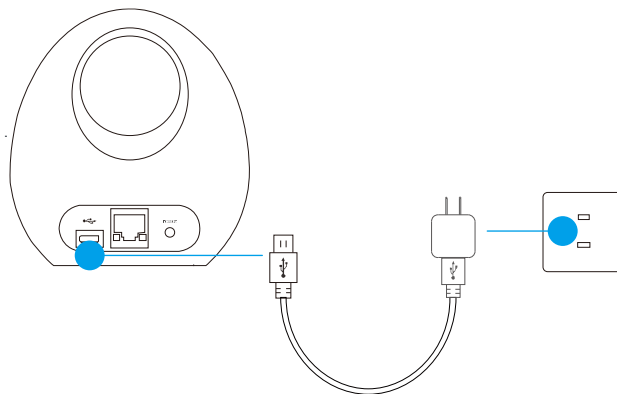

Figure 3-1 Power on the Base Station

Note:

The circular LED indicator (**SYNC Button**) turns solid blue, when the base station is started up.

3. Connect the base station to an open LAN port on your router using the included Ethernet cable.

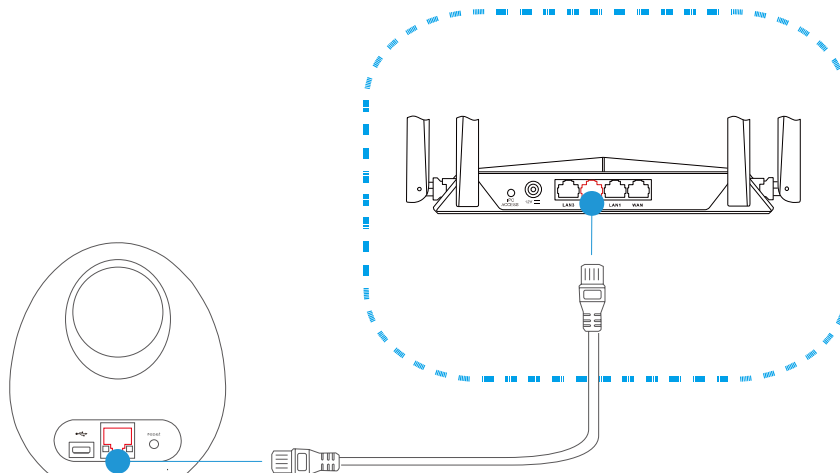

Figure 3-2 Connect the Base Station to the Network

Note:

The circular LED indicator (**SYNC Button**) turns solid green, when the base station is connected to the network.

Chapter 4 Get the EZVIZ App

Download the free EZVIZ app to set up your base station and camera. This app provides step-by-step instructions.

Steps:

1. Connect your mobile phone to the Internet.
2. Search for EZVIZ in the App Store or Google Play (™).
3. Download and install the EZVIZ app.
4. Launch the app, register an EZVIZ user account.



Note:

If you have already used the app, make sure that it is the latest version. To find out if an update is available, go to the App store and search for EZVIZ.

Chapter 5 Use the EZVIZ App for Installation and Setup

Installation and Setup

Use the EZVIZ app to install and set up your base station and camera. The EZVIZ app guides you through setup in this order:

1. Create your EZVIZ account. You can use the same account to manage all your EZVIZ devices.
2. Connect the EZVIZ base station to the Internet and add it to your account.
3. Link each EZVIZ camera with the base station.

Steps:

1. Connect your mobile device to the Internet.
2. Log in the EZVIZ App.
3. At the Home screen, tap “+” on the upper-right corner to go to the scan QR code interface.

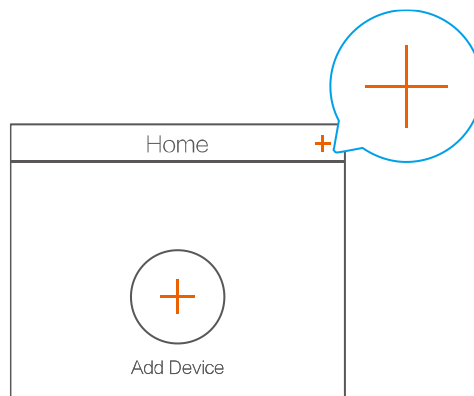

Figure 5-1 Home Screen

4. Scan the QR code on base station or manually enter the serial number to go to the **Add Device** Interface.

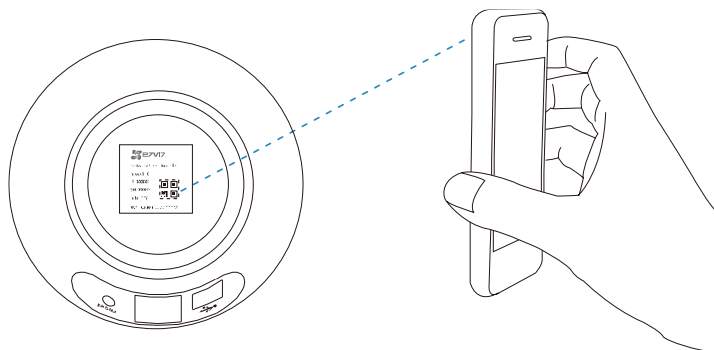

Figure 5-2 Scan the QR Code

5. Tap **Add** button.
6. Please make sure your base station is powered on.

The circular LED indicator (SYNC Button) turns solid blue, when the base station is started up.

7. Please make sure your base station is connected to the network, and tap **Next** button.



Figure 5-3 Confirm

The circular LED indicator (SYNC Button) turns solid green, when the base station is connected to the network. Please wait patiently for the base station to be added to your EZVIZ account.

8. Your EZVIZ app turns to **Device Setup** Interface, when the base station is added to your EZVIZ account successfully.

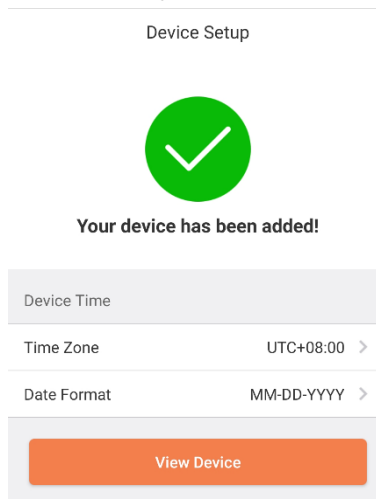

Figure 5-4 Device Setup Interface

9. Tap **View Device** button to go to your base station setup interface.
10. Tap **Go to Add** button to link camera(s) to your base station.
*You can also tap the **Finished** button to finish the settings.*

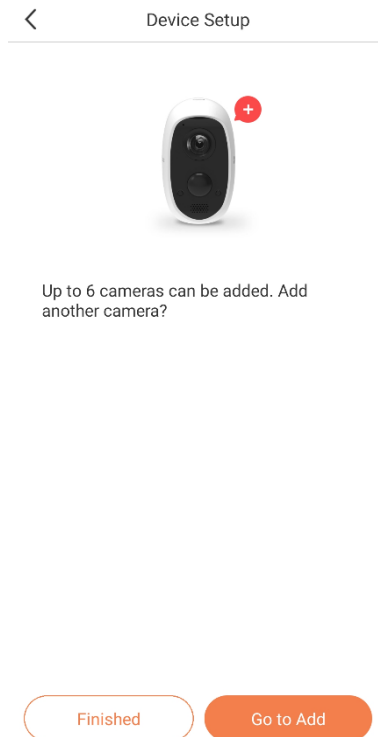

Figure 5-5 Device Setup Interface

- *Before the synchronization, it is suggested to fully charge your camera.*
 - *After the battery is charged, and before the synchronization progress, please disconnect all the charging cables.*
11. Once your camera is fully charged, bring it close to the base station (within 2 feet to 3 feet (0.6 to 1 m)).



Figure 5-6 The Distance between Base Station and Camera

12. Tap **Next** button.
13. Press and hold the **SYNC** button on the camera for about 6 seconds until you hear your camera has been reset successfully.



Figure 5-7 Press and Hold the **SYNC** Button

14. Tap **Next** button.
15. Press the **SYNC** button on the base station. The circular LED indicator flashes blue when the base station starts to synchronize.



Figure 5-8 Press the **SYNC** Button

16. Tap **Next** button.
 - *The camera LED indicator fast flashes blue, when the camera starts to synchronize.*
 - *The synchronization process lasts about 2 minutes. After 2 minutes, press the **SYNC** button again if you want to add more cameras.*
17. Wait for about 150 seconds, and tap  to refresh the page.

Camera(s) may take up to 150 seconds to appear in the Add Device list on the EZVIZ APP.

 - *The camera LED indicator fast-flashing red indicates the sync has failed, and you can repeat the steps 13-16 to try again.*
 - *When the camera LED indicator slowly flashes blue, synchronization is complete.*

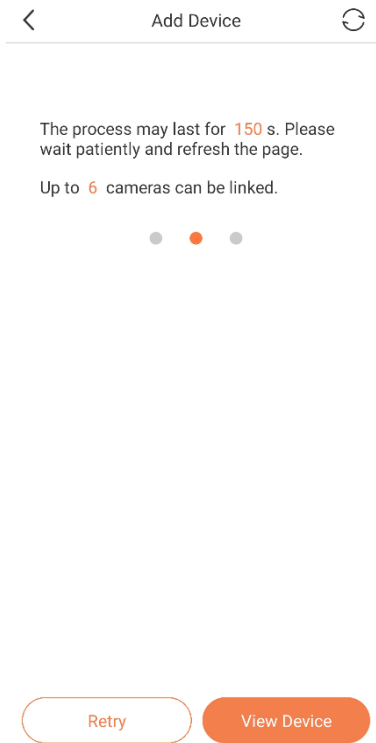

Figure 5-9 Refresh the Page

18. You have added the camera to your base station successfully.

- Repeat the steps 13-18 if you want to synchronize more cameras to the base station.
- Up to 6 cameras can be linked to a base station.

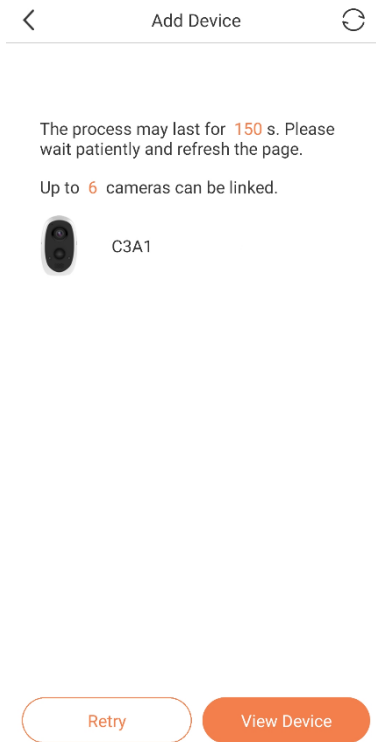

Figure 5-10 Linked Camera

Chapter 6 Place or Mount Your Camera

You can place your camera on a flat surface or you can mount it on a wall. Choose a location with a clear, unblocked field of view where camera can receive strong signal emitting from your base station.

Note:

Wi-Fi range will be affected by building materials or objects that will block Wi-Fi signals and by interference from other Wi-Fi networks.

6.1 The Wall Mounting

Your camera comes with accessories that you can use to mount your camera.

6.1.1 Option 1: Secure the metal plate with screws.

- (1) Place the drill template onto a clean and flat surface, indoors or outdoors.
- (2) (For cement wall/ceiling only) Drill screw holes according to the template, and insert anchors.
- (3) Use screws to fix the metal plate according to the template.
- (4) Place your camera on the mount.
- (5) The magnets in the camera keep it in place.

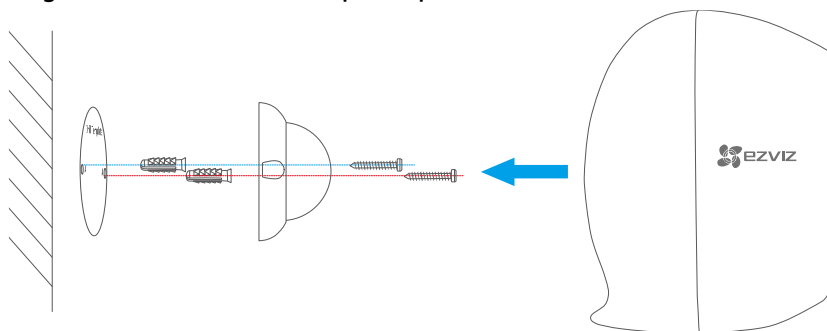

Figure 6-1 Secure the Metal Plate with Screws

6.1.2 Option 2: Secure the metal plate with foam sticker.

- (1) Pick a clean and flat surface, indoors or outdoors.
- (2) Secure the metal plate with the foam sticker.
- (3) Mount the camera to the metal plate or attach it directly to a magnetic surface.

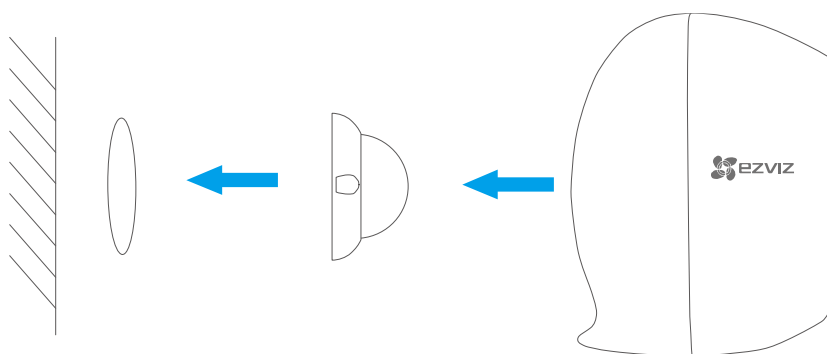

Figure 6-2 Secure the Metal Plate with Foam Sticker

6.2 Find a Good Spot for Your Camera

How to find a good spot for your camera? Keep the following tips in mind:

- Camera and base station should be placed as close to each other as possible for optimal performance, and should not exceed 300 feet (100 m). Avoid placing next to or behind barriers and/or wireless devices, which may significantly decrease the communication range.
- Your camera provides a 126-degree viewing angle. Position your camera(s) to make sure what is most important to you is properly positioned within the cameras' field of view.
- Your cameras motion sensor is far more sensitive to side-to-side movement across their field of view. The best area for motion detection is 5 feet to 25 feet (1.5 to 7.5 m) from the cameras position.
- Remember that the camera uses a built in PIR sensor to detect body heat and provide more relevant motion detection alerts and recordings. To further minimize false alarms, try to avoid high traffic areas like streets with many moving vehicles or other scenes with a high contrast of heat that may also trigger the sensor.

6.3 Position Your Camera to Optimize Its Field of View

The field of view is the area in which the camera can detect motion. Your camera provides a 126-degree viewing angle. When positioning your camera, keep the following tips in mind:

Notes:

- Position your cameras to make sure the scene you want to video is within the cameras' field of view.
- Don't block the camera's field of view. Make sure that no walls, tables, or other objects are too close to your camera. If an object is within 2.5 inches (6.4

centimeters) of the sides or front of your camera, that object can reflect infrared (IR) light back into the camera lens, causing glare or hazy video, especially at night.

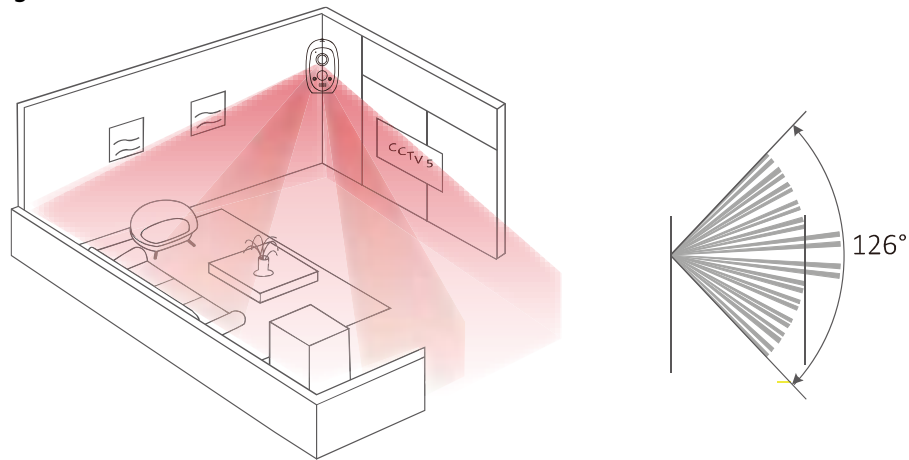

Figure 6-3 Position Your Camera





Chapter 7 LED Indicator Guide

7.1 Base Station LED Indicator



Figure 7-1 Circular LED Indicator

Table 7-1 Descriptions of the Circular LED Indicator







	Solid Green	The system is working properly.
	Solid Blue	The base station is not connected to the Internet.
	Flashing Blue	The base station is starting synchronization with the camera.
	Off	The base station is turned off.

7.2 Camera LED Indicator



Figure 7-2 Camera LED Indicator

Table 7-2 Descriptions of the Camera LED Indicator

	Solid Red	Camera starting up.
	Slow-flashing Red	Camera charging/Network exception.
	Fast-flashing Red	Camera exception (e.g. Micro SD card error) /Low battery.
	Solid Blue	Video being viewed in the EZVIZ app.
	Slow-flashing Blue	Functioning properly.
	Fast-flashing Blue	Camera ready for Wi-Fi configuration. / Synchronization in progress.

Chapter 8 Use a Micro SD Card

All recordings are stored to the cloud, but with a camera, you can use a micro SD card as a backup choice to store recordings. Insert a micro SD card (sold separately), and initialize the card in the EZVIZ app before using it.

If you install a micro SD card in the camera, the camera records motion-triggered clips to both the cloud and the micro SD card. If the camera is powered on, but not connected to the Internet, it continues to record to the micro SD card.

Note:

We support micro SD cards, class 10, up to 128 GB capacity, file format FAT32.

8.1 Insert a Micro SD Card

Steps:

1. Unlock the battery compartment by pressing and holding the latch, at the same time gently pull back the battery cover to open the compartment.

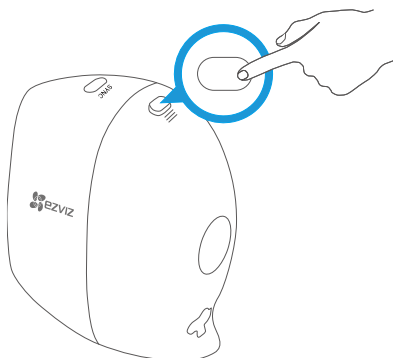

Figure 8-1 Unlock the Battery Compartment

2. Insert a micro SD card into the micro SD card slot.

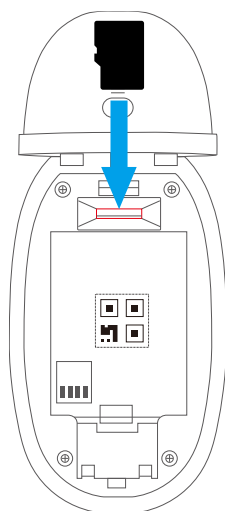



Figure 8-2 Insert a Micro SD Card

8.2 Initialize a Micro SD Card in the EZVIZ App

We support micro SD cards, class 10, up to 128 GB capacity, file format FAT32. You should initialize the card in the EZVIZ app before using it.

Steps:

1. At the home screen, tap  to go to the camera **Settings** interface.

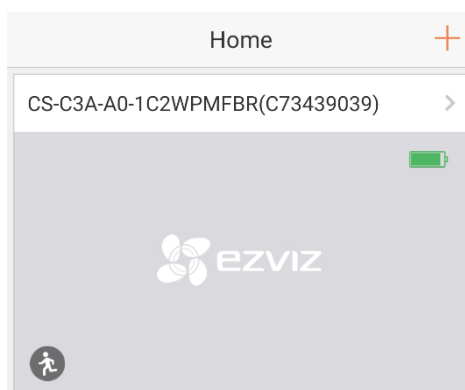

Figure 8-3 Home Screen

2. Tap **Storage Status** -> **Memory Card**, and then tap **Initialize** button to initialize the card.

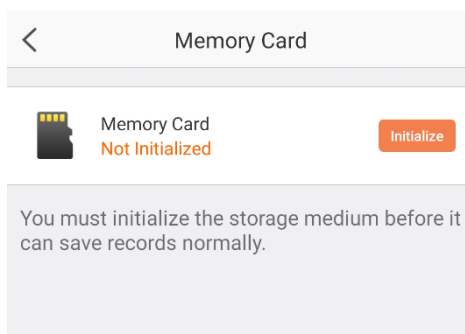

Figure 8-4 Initialize the Memory Card

Notes:

- Check the memory card status by tapping **Storage Status** in the camera **Settings** interface.
- After the card is initialized, the status turns normal.

8.3 View the Micro SD Card Status for a Camera

The EZVIZ app will notify you if the micro SD card is getting full or if the micro SD card is not the correct format. You can also use the app to view the card status.

Steps:

1. At the home screen, tap  to go to the camera **Settings** interface.

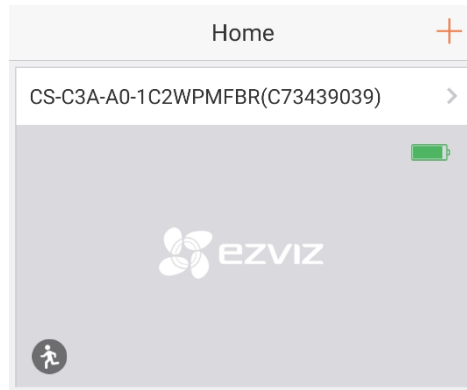

Figure 8-5 Home Screen

2. Tap **Storage Status**, you will see the status of the micro SD card.

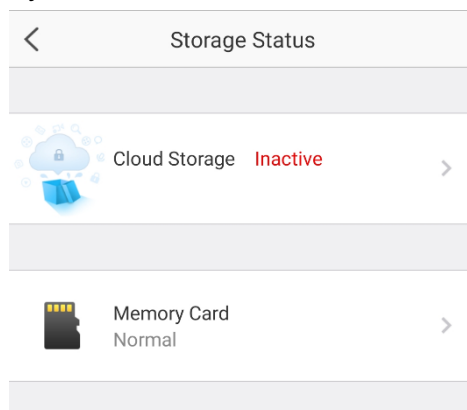

Figure 8-6 Memory Card Status

Chapter 9 View Your Camera

Videos recorded by your camera are stored in a library. You can view your recordings and snapshots, and share them with anyone you want.

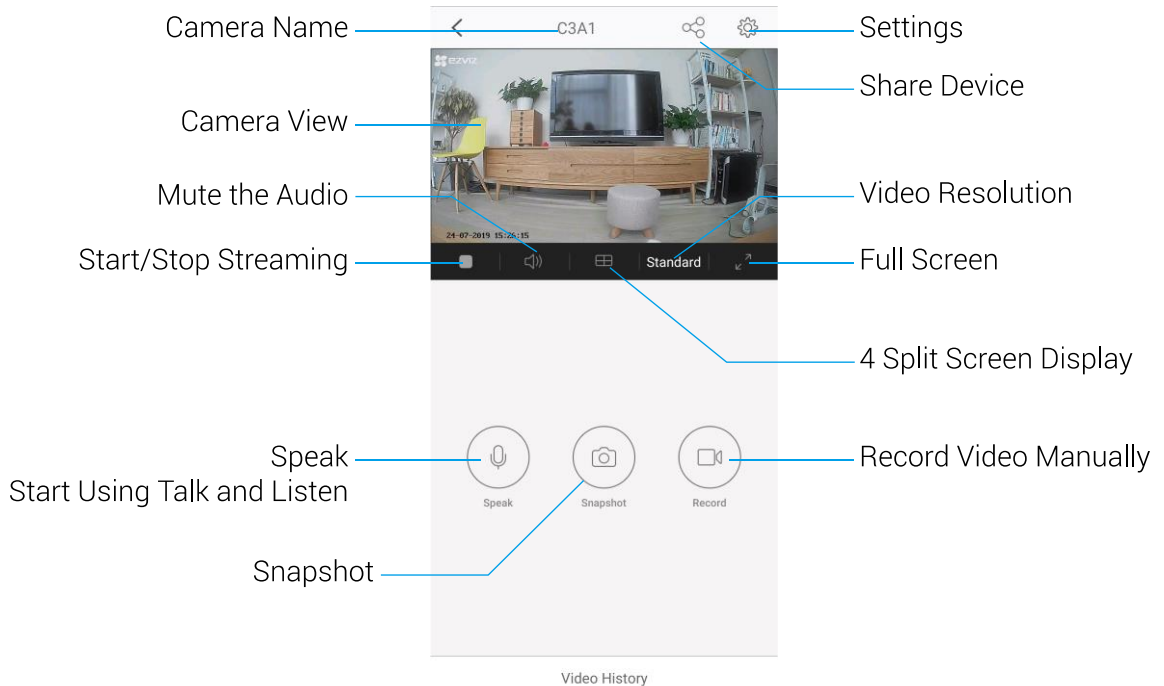









Figure 9-1 Device information

Table 9-1 Descriptions of the Toolbar and Live View Parameters

Icon	Description
	Share device. Tap the button to share your device with anyone you want.
	Tap to view or change the camera settings.
	Start/Stop streaming.
	Audio on/Mute.
	4 split screen display/Single-screen display.
	Zoom-in/Zoom-out.
	Tap to start using talk and listen. Steps: 1. Tap , and it appears . 2. Hold button to talk, release it to listen.

	3. Tap  to stop.
	Take a snapshot.
	Manually start/stop recording.
	Tap  to select the video resolution from    .

Chapter 10 Troubleshooting

Q: Why does the battery run out of power within just a week or less?

A: Actually the battery life depends on alarm trigger and network stability. First of all, please check if there are too many alarms triggered, resulting in a large number of video recordings. Then check if the distance between camera and base station is too far, whether there is barrier or radio interference to cause unstable network.

Q: How many cameras can the base station support at most?

A: 6 cameras.

Q: If the camera is offline, will the video recording be continued?

A: If the camera is powered on but disconnect to the Internet, then video recording on micro SD card will continue but cloud recording will stop. If the camera is powered off, both video recordings will stop. However, make sure the camera is offline instead of not being linked to the base station. Video recordings cannot be viewed until the network configuration is finished.

Q: Why the alarm is triggered when nobody in the picture?

A: Please try to set the alarm sensitivity lower. Please notice that vehicle and animals are also the trigger source.